



# Apogee Duet

User's Guide-Ver 2.0

June, 2016



# Contents

[Contents](#)

[Introduction](#)

[Package Contents](#)

[Duet panel tour](#)

[Getting Started](#)

[Connecting to your Mac](#)

[Connecting to your iPad](#)

[Analog Inputs](#)

[Analog Outputs](#)

[MIDI](#)

[Maestro Software](#)

[Operation](#)

[Configuring the Input](#)

[Configuring the Output](#)

[Adjusting Input & Output Levels](#)

[Low Latency Mixing](#)

[Setting Sample Rate](#)

[Touchpads](#)

[Software Setup](#)

[Mac OS: Using Duet with Logic](#)

[Mac OS: Using Duet with Avid Pro Tools](#)

[Mac OS: Using Duet with Ableton Live](#)

[Using Duet with iOS Apps](#)

[Troubleshooting](#)

[Additional Support](#)

[Duet Specifications](#)

[Warranty & Notifications](#)

# Introduction

Thank you for purchasing Duet. This User's Guide describes how to set up Duet with your Mac and iPad, connect speakers or headphones to play back music and connect mics and instruments to record your own creations.

## Duet for iPad/Mac

### The Industry Standard for Personal Recording

Apogee Duet is an award-winning audio interface, headphone amp and MIDI interface making it easy to create professional recordings anywhere on your iPod touch, iPhone, iPad or Mac. With Apogee's legendary digital audio conversion and world-class mic preamps, Duet is the best way to capture your music with incredible dimension and detail.

The new Duet for iPad and Mac features special circuitry designed to deliver professional performance for iPad use along with low latency USB 2.0 performance for Mac. And with the addition of MIDI I/O you can connect and power a Core MIDI compatible keyboard/controller while using Duet with your iPad or iOS device.

## Legendary Sound Quality

### Why Apogee Duet is the best choice for your studio

Apogee is an award-winning industry leader in digital recording technology with over 25 years of experience. Preferred by recording pros around the world, Apogee products like Duet, Ensemble and Symphony I/O have been instrumental in creating countless GRAMMY® and OSCAR® winning recordings and have set the industry standard in professional recording for over two decades. Duet is built solidly on this reputation.

# Package Contents

The following items are included in the Duet box:

- Duet
- Breakout cable with:
  - 2 combination line/mic/instrument inputs
  - 2 balanced line outputs
- 2 meter USB cable
- Universal power supply with NA, EU, UK, AU, JP
- QuickStart Guide



QuickStart Guide



Universal Power Adapter  
for US, EU and UK



2 Meter USB Cable



Breakout Cable

*Note:* Lightning iOS cable sold separately.

**Please register your product and download the latest installer here:**

[www.apogeedigital.com/downloads](http://www.apogeedigital.com/downloads)

**Please note:** This user's guide is for Duet iPad/Mac, if you would like to download Duet 2 user's guide please go to the link above and look for Duet 2 downloads.



## Duet panel tour



### Full Color interactive OLED Display

Duet's OLED display provides full color visual feedback and metering.

### Multi-function Controller Knob

Duet's multi-function controller knob allows you to easily switch between Inputs and Outputs as well as adjust their levels.

### User Assignable Touchpads

Duet's two assignable touchpads can be assigned to control many of Duet's settings and parameters. Use them to setup advanced muting functions when recording yourself or to toggle between outputs.

### 1/4" Stereo Headphone Output

Duet includes a 1/4" stereo headphone output that is independently controlled and separate from the stereo speaker line outputs.

## MIDI

Duet provides a single USB MIDI connection for your CoreMIDI compatible keyboard, synth, or DJ controller. This eliminates the need for an external MIDI interface and promotes an all-in-one music creation solution. On iPad, Duet's MIDI connection allows both Duet and a keyboard or DJ controller to be connected at the same time to the iPad's single dock port.

## Analog In and Out

This port is for connecting Duet's breakout cable. The breakout cable includes 2 combination mic/instrument connectors (XLR and 1/4" built into a single connector) and 2 balanced 1/4" connectors for speakers. The elegant single cable-to-junction design allows for easy cable management and the locking connection to Duet is robust and stylish.

## DC Power

Duet is easily powered by any available USB port on your Mac in most applications. However there may be scenarios where connecting the external AC power adaptor is required.

### **Connection to iOS Devices (iPad, iPhone, iPod touch)**

When connected to iPad, iPod Touch, or iPhone, the DC power supply for Duet **MUST** be used. Duet will charge your iPad while you record so your work will not be interrupted.

### **Connection to Mac: Increased Duet Power Consumption Exceeds USB Bandwidth**

When connecting to a Mac, Duet can be powered via the USB cable alone. However if the following message appears, connect DC power to the Duet:



*This will appear on the OLED if the external power is necessary with Mac*

Here are the circumstances that may trigger this message:

- Output volume into low impedance headphones
- Power-hungry condenser mics are connected.

If you have Duet set at a reasonable output volume and are not drawing a significant amount of power over the USB bus, you will be able to connect any microphones that require phantom power. When you are using low impedance headphones and your volume is very high, you are drawing more power over the USB bus and may need the AC adaptor to use power hungry condenser mics.

## USB

Duet includes a USB 2.0 cable providing High Speed connection to Mac. Direct digital connection to iPad and iOS devices is also available (Lightning and 30-pin cables sold separately).

## OLED Screen Tour

### Home View

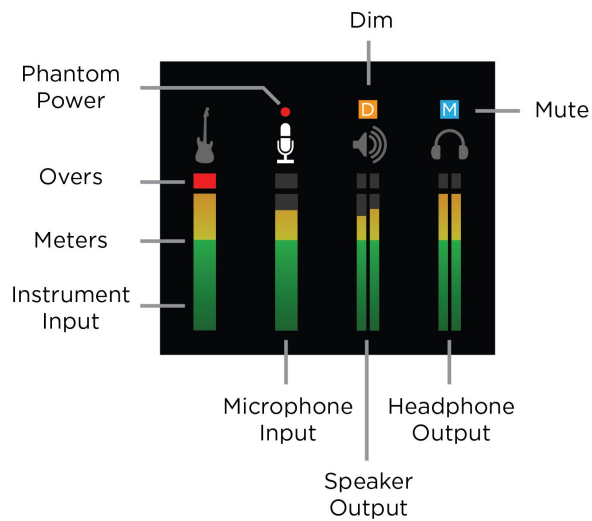

### Detail View (Input)

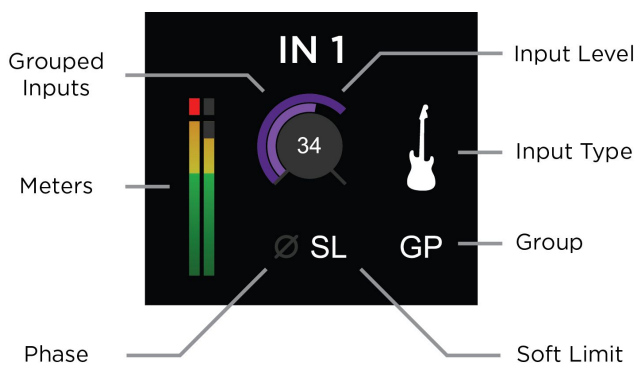

### Detail View (Output)

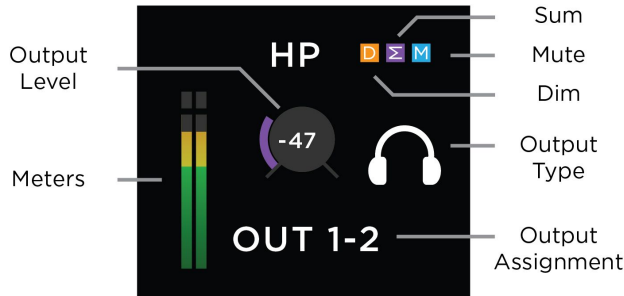

## Getting Started

### Connecting to your Mac

#### System Requirements

- Computer: Intel Mac 1.5GHz or faster
- Memory: 2 GB RAM minimum, 4 GB recommended
- OS: 10.6.8, 10.7.5 or greater
- Connection and power: Any available USB port on a Mac
- USB bus powered; DC power optional (DC power supply included)

#### Install Duet Software

1. Connect Duet to a USB port on your Mac using the supplied USB 2 cable.
2. Go to [www.apogeedigital.com/support/duet-ios-mac](http://www.apogeedigital.com/support/duet-ios-mac)
3. Download the latest Duet for iPad & Mac Installer.
4. Once you have downloaded the file, open it and double-click the firmware updater.app that's inside.
5. After the firmware update has completed, double-click the Duet Software Installer.pkg and follow the prompts that appear.
6. You will be required to restart your computer after the install is complete.

#### Choosing Duet for Mac Sound I/O

After connecting Duet, installing the software and restarting your Mac, a dialog box will prompt you to choose Duet for Mac sound input and output. **Click Yes.**

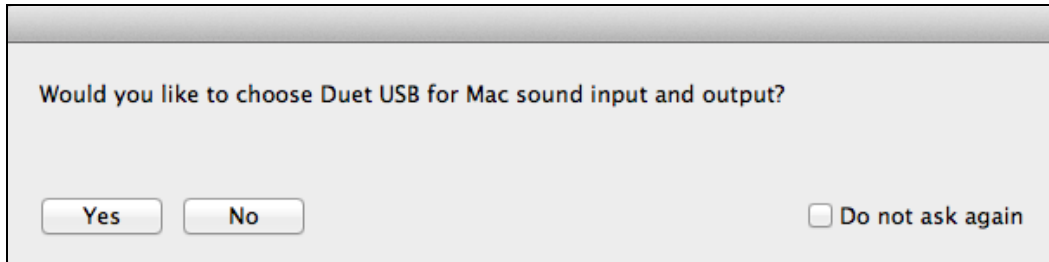

## Connecting to your iPad

### System Requirements

- iOS version: 5.1.1 and later
- DC power required: DC power supply included

### Works with these iOS devices:

iPhone 4 and newer,  
iPad 2 & newer, iPad Air and newer, iPad mini and newer, iPad Pro and newer  
iPod Touch

### iOS Cable not included:

Requires Lightning or 30-pin cable for connection to an iOS device. Cables are available directly from Apogee's website, most authorized retailers and Apogee distributors worldwide For more information on where to purchase, visit [www.apogeedigital.com](http://www.apogeedigital.com)

### Install Apogee Maestro from App Store

1. Connect Duet to your iPad/iPhone using a Lightning or 30-pin iOS cable (sold separately)



2. Connect the provided external power supply to Duet. When connecting to iPad/iPhone, the external power supply is required.



3. On the iPad/iPhone, open Settings and choose General > About > Duet, then choose "Find App for Accessory".

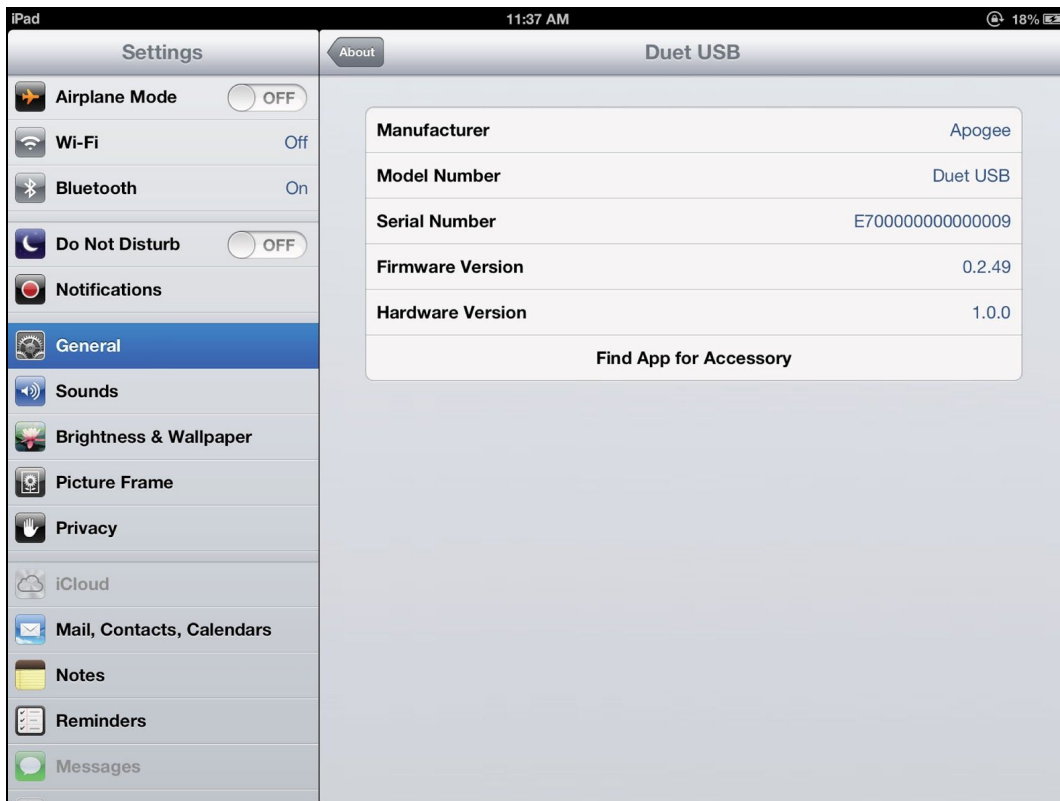

The App Store will open and navigate automatically to the Apogee Maestro app. Or you can go to App store and search for the app.

4. Once you've signed in to the App Store, download Apogee Maestro.



Note: it's possible to record through the mic inputs and playback audio without installing Maestro. To change the input source, enable phantom power, or to access advanced hardware controls, you'll need to install Maestro app.

## Analog Inputs

1. Connect the provided breakout cable to the Analog I/O port on the rear of the unit.
2. Connect your analog input source(s) to either of the 2 combination connectors on Duet's breakout cable:



**Microphone:** XLR connection to Duet's combination connector

**+4 dBu/-10 dBV line level device:** XLR connection to Duet's combination connector



**Instrument:** 1/4" connection to Duet's combination connector

**Note:** Input source must be selected within Apogee's Maestro application.

[See Configuring the Input Section>](#)

3. To adjust the input gain level, press Duet's Multi-function Controller Knob until either the microphone or instrument icon is lit on the Duet's display.

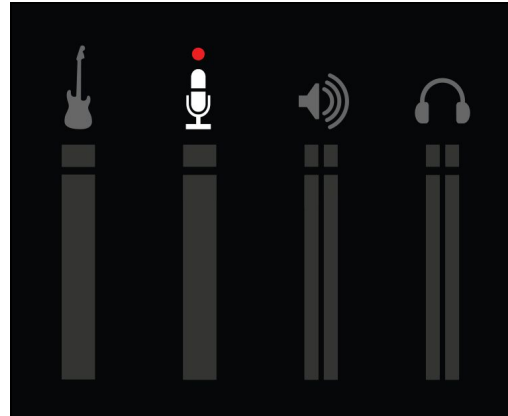

Then turn the knob clockwise to increase the input gain level.

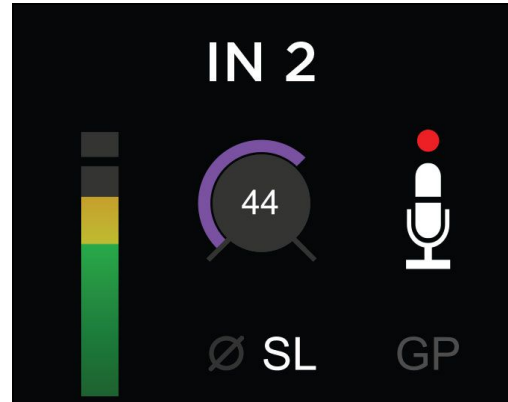

[Learn more about adjusting input/output levels here>](#)



## Analog Outputs

1. Connect the provided breakout cable to the Analog I/O port on the rear of the unit



2. Connect your left and right speakers to the respective 1/4" TRS balanced output connectors on Duet's breakout cable.



3. Connect headphones to the 1/4" headphone jack on Duet's front panel.



4. To adjust the volume, press Duet's Multi-function Controller Knob until the speaker or headphone icon is lit on the display's Home View and turn the knob clockwise to increase the volume.
5. Playback audio from iTunes to verify output.

[Learn more about adjusting input/output levels here>](#)

## MIDI

Duet's USB MIDI input/output provides a MIDI connection between class compliant Core MIDI devices such as keyboards and other controllers and Apple's Mac OS X and iOS operating systems.

A class-compliant MIDI device works with Core MIDI without the need to install drivers or other additional software. To confirm that your MIDI device is class-compliant refer to the manufacturer of the device.

## Maestro Software



Access all control functions and settings with Maestro, Apogee's comprehensive software control application. Maestro features a single window interface with quick access to all Apogee device settings. Select your input type, enable Soft Limit on mic and instrument inputs, and use the mixer for low latency monitoring. Maestro lets you easily configure your Apogee interface to fit your workflow.

Maestro, Apogee's free app for iOS, brings total hardware control to iPad. Designed to create a seamless transition between Mac and iOS, Maestro's design was customized for each device; iPhone, iPad and Mac, ensuring an intuitive user interface across every platform. The app includes all the same essential functions available on the Mac including low latency monitoring. Maestro can be downloaded for free from the Apple App Store on your iPod Touch, iPhone, or iPad.

# Input

## Input Tab for Mac

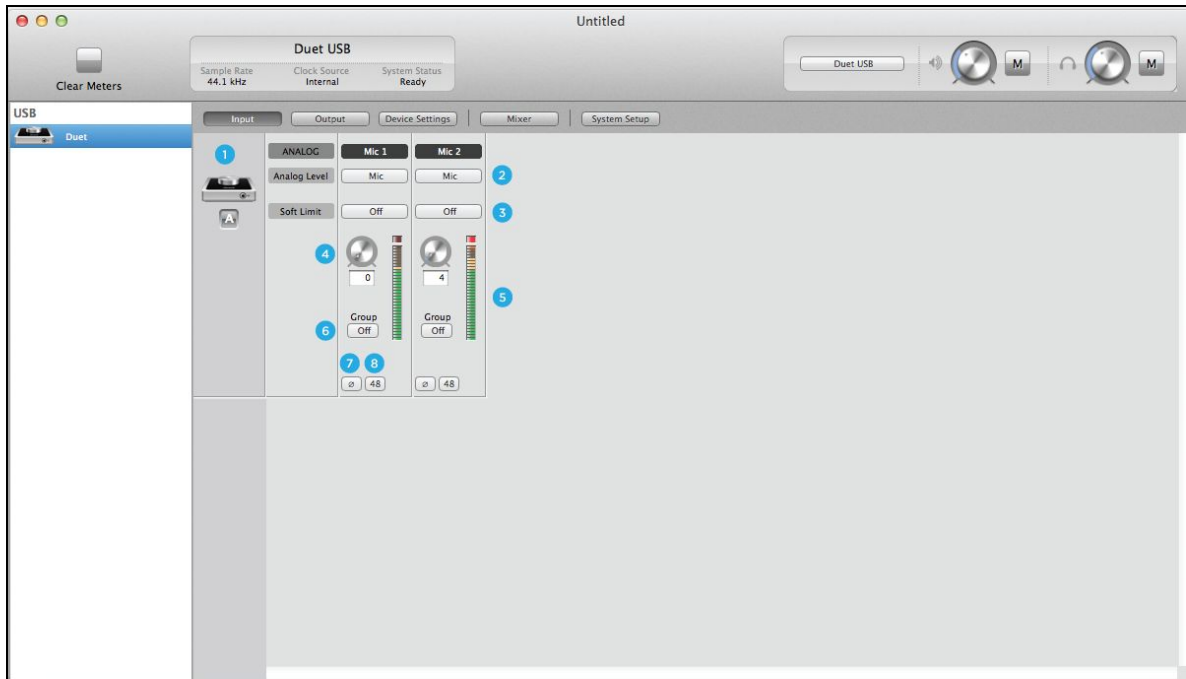

## Input Tab for iOS



1. **Device Icon & ID Button (Mac only)** - A device icon and ID button is placed adjacent to each row of parameters to identify the hardware unit to which the row belongs. By clicking on the ID button, the corresponding hardware unit's front panel will illuminate. Each hardware unit is assigned a Peripheral Prefix which is displayed on the ID button.
2. **Analog Level** - Use this menu to select microphone, instrument, or line input.
3. **Soft Limit** - Use this menu to engage Soft Limit. Soft Limit is Apogee's proprietary analog process for taming transients before A/D conversion. By gently rounding transients in a transparent manner, it's possible to maximize level BEFORE the A/D conversion stage. Soft Limit is most effective with signals with large transients such as drums, percussion and plucked instruments. Soft Limit may not be the appropriate choice for signals such as bass or organ.
4. **Input Level** - The gain of each input is controlled with these software knobs. The gain level is indicated in the value box below the knob.
5. **Analog Input Meter** - This meter displays the level of the analog input after A/D conversion.
6. **Group On/Off** - Use this to group the gain setting of both inputs so that the multi-function knob on Duet or one software gain knob controls both input gains simultaneously. If a gain offset is present between inputs when Group is set to On, this offset is preserved.
7. **Phase** - Check this box to reverse the polarity of the input signal. Under certain circumstances, when two mics are used on one source, reversing the polarity of one mic may result in a fuller sound. For example, when a top and bottom mic is used on a snare drum, a fuller sound is obtained when the polarity of the bottom mic is reversed.
8. **48 V / Phantom Power** - Engage this button for 48 volts phantom power on the XLR connections. Condenser mics require phantom power to operate.

## Output

### Output Tab for Mac

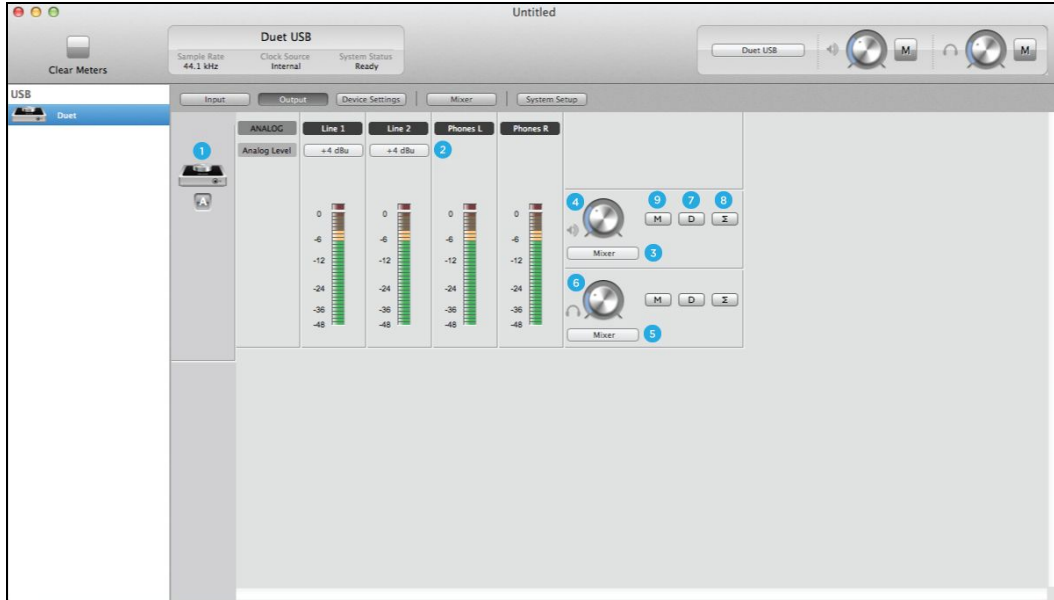

### Output Tab for iOS



1. **Device Icon & ID Button (Mac only)** - A device icon and ID button is placed adjacent to each row of parameters to identify the hardware unit to which the row belongs. By clicking on the ID button, the corresponding hardware unit's front panel will illuminate. Each hardware unit is assigned a Peripheral Prefix which is displayed on the ID button.
2. **Analog Output Meter** - This meter displays the level of the analog output before D/A conversion, in the range -48 to 0 dBFS.
3. **Speaker Out Selection** - This menu selects the output source that is sent to the speaker outputs.
4. **Speaker Out Level** - This knob controls the speaker output level.
5. **Headphone Out Selection** - This menu selects the output source that is sent to the headphone outputs.
6. **Headphone Level** - This knob controls the output level of the front panel HP 1 output.
7. **Dim** - Engage dim if you want to lower the output level by 15 dB. This function is convenient when you want to briefly lower the playback volume in the speakers or headphones in order to hold a conversation without completely muting the output. Duet's top panel touch buttons may be set to engage Dim on the Speaker outputs, the headphone outputs or both at the same time. [See Device Settings Tab Window.](#)
8. **Sum to Mono** - Engage this to sum the left and right channels of the output to mono. At many points of the production process, this function is useful to check mono compatibility. For example, when recording with a stereo pair of mics, it's always a good idea to sum both channels to mono and check for unevenness in the frequency range caused by phase cancellation and reinforcement of particular frequencies. If the sound changes significantly or sounds "hollow" when summed to mono, this may indicate phase issues caused by a less than optimal mic placement. When mixing, it's also a good idea to check mono compatibility. Beyond questions of phase, any masking caused by overlapping frequencies is most easily heard when listening in mono. Try starting a mix with Sum to Mono engaged - once you have something that sounds good, then disengage Sum to Mono and revel at the beautiful stereo mix you've created! Duet's top panel touch buttons may be set to engage Sum to Mono on the Speaker outputs, the headphone outputs or both at the same time. [See Device Settings Tab Window.](#)
9. **Mute** - Engage this to mute the output.



## Mixer

### Mixer Tab on Mac

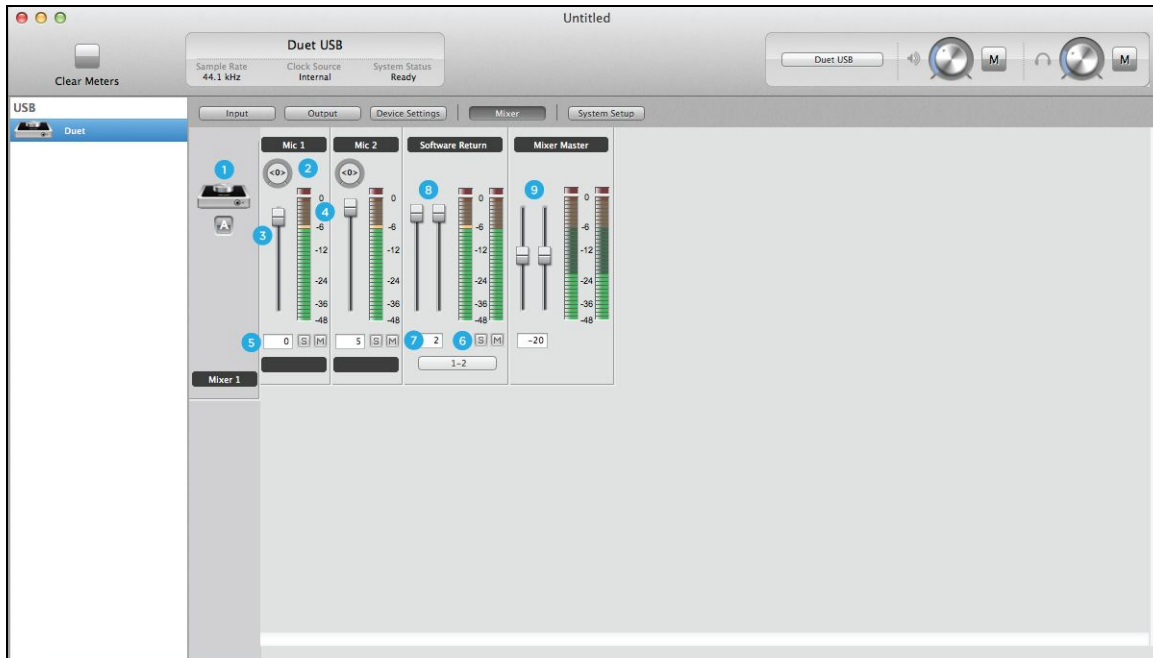

### Mixer Tab on iOS



1. **Device Icon & ID Button** - A device icon and ID button is placed adjacent to each row of parameters to identify the hardware unit to which the row belongs. By clicking on the ID button, the corresponding hardware unit's front panel will illuminate. Each hardware unit is assigned a Peripheral Prefix which is displayed on the ID button.
2. **Pan** - This rotary knob pans the input signal between the left and right sides of the Maestro mixer's stereo output.
3. **Input Level fader** - This slider sets the level of the input signal in the Maestro mixer's stereo output.
4. **Meter** - This bargraph style meter displays the pre-fader input level.
5. **Input Level value Window** - The Input Level fader value is displayed in this window. Fader values between 6 and -48 may be directly entered.
6. **Solo** - This button mutes all other channels whose Solo buttons are not engaged.
7. **Mute** - This button mutes the input channel.
8. **Software Return Fader** - This stereo input channel provides level control, metering, and mute/solo functions for the signal from the software application containing playback. Match your recording software application's mixer output and the Software Return menu selection. In most cases, the recording software mixer output and Maestro's Software Return will be set to 1-2.
9. **Mixer Master** - This is the level control and meter for the mixer's output.

## Device Settings

### Device Settings Mac

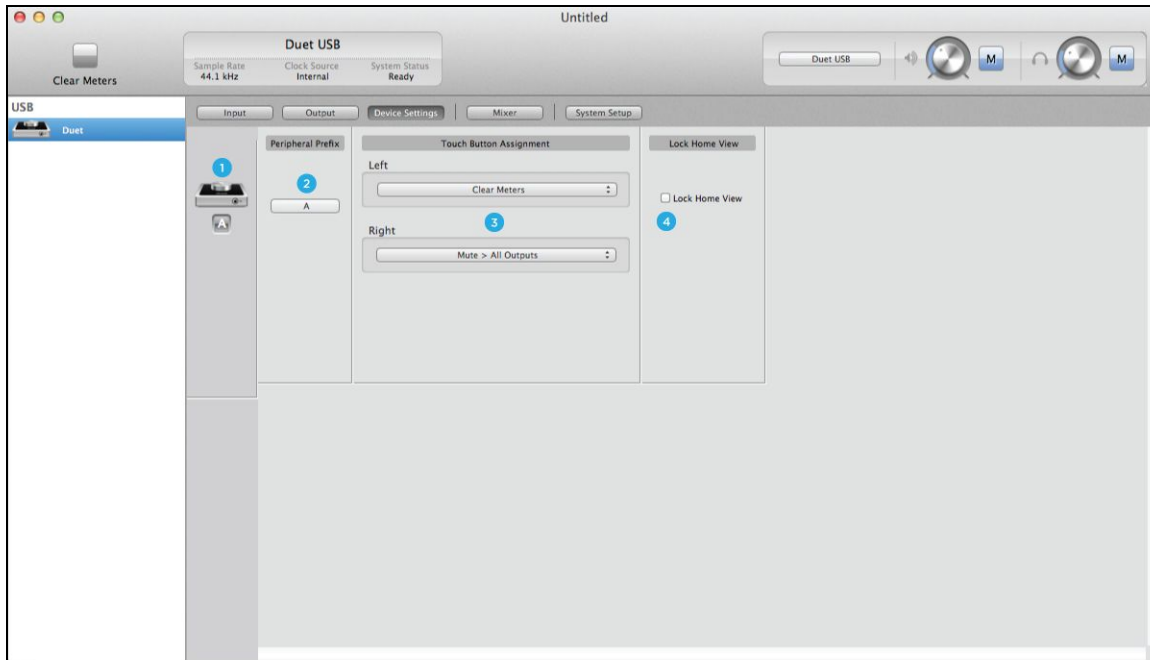

### Device Settings iOS

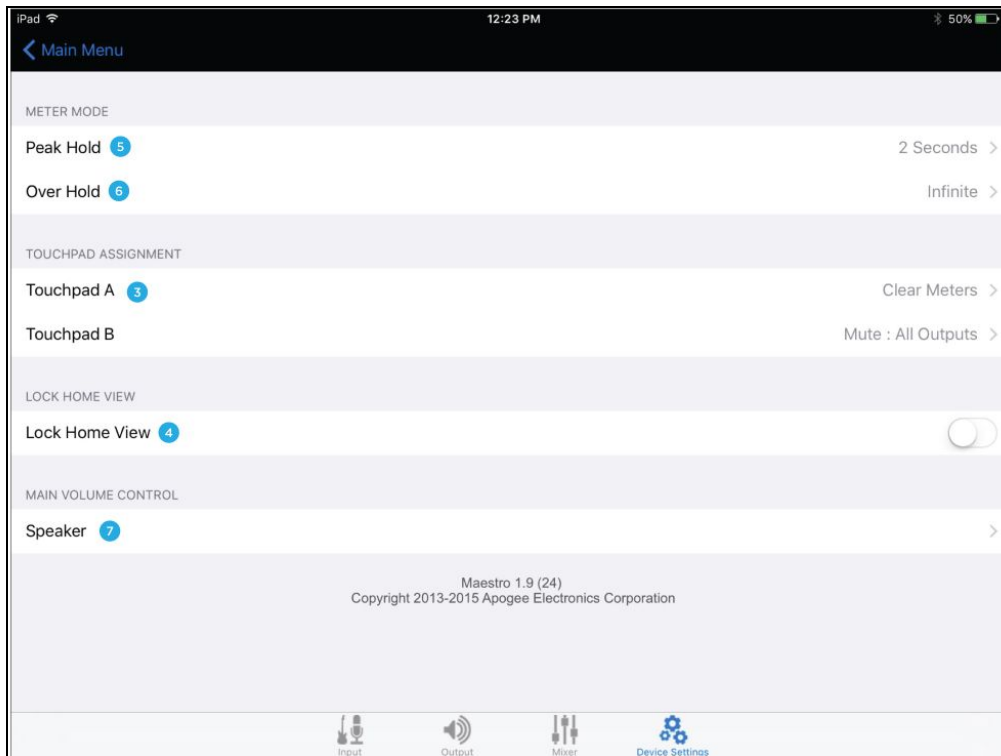

1. **Device Icon & ID Button (Mac only)** - A device icon and ID button is placed adjacent to each row of parameters to identify the hardware unit to which the row belongs. By clicking on the ID button, the corresponding hardware unit's front panel will illuminate. Each hardware unit is assigned a Peripheral Prefix which is displayed on the ID button.
2. **Peripheral Prefix (Mac only)** - Use this drop down menu to assign a letter prefix (A-Z) to each peripheral device displayed in the Devices Sidebar. The letter prefix is included in all graphic representations of the peripheral as well as I/O labels in Maestro and Core Audio compatible applications.
3. **Touchpad Assignment** - Use these menus to select the parameter controlled by the user assignable touchpads.
  - Mute outputs:** To mute the speaker and headphone outputs, assign one of the user assignable touchpads in Maestro to the desired mute function.
  - Dim outputs:** The Dim function lowers the output volume by 15 dB. This function is convenient when you want to briefly lower the playback volume in the speakers or headphones in order to hold a conversation without completely muting the output.
  - Sum to Mono:** The Sum to Mono function is used to examine phase relationships on stereo tracks. When it is engaged, phase errors become more noticeable.
  - Toggle Headphone source:** Used to switch the Headphone output between Out 1-2, Out 3-4 and Mixer. This function is especially useful for digital DJs to switch the headphone output between the House output (sent to Out 1-2) and a cue output (sent to Out 3-4).
  - Clear Meters:** The Clear Meters function will remove held peak and over indicators on software and OLED meters when Peak Hold or Over Hold (in the System Setup tab window) is set to Infinite.
4. **Lock Home view** - When Lock Home view is checked, the OLED display doesn't jump to the Detail view when the Controller knob is turned. If Lock Home view is not checked, the OLED display shows details for the selected input or output when the Controller knob is turned.
5. **Peak Hold (on iOS)** - This pop-up menu sets the time that peak indications are held on software and front panel meters.
6. **Over Hold (on iOS)** - This pop-up menu sets the time that over indications are held on software and front panel meters.
7. **Speaker (on iOS)** - This pop-up menu sets the main volume control to speaker or headphone.

## System Setup (Mac only)

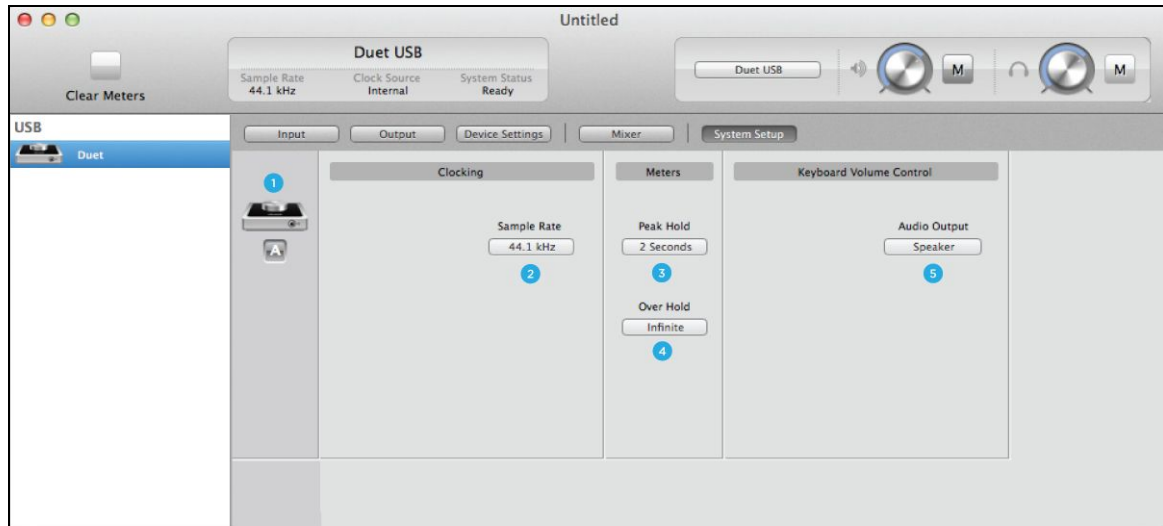

1. **Device Icon & ID Button (Mac only)** - A device icon and ID button is placed adjacent to each row of parameters to identify the hardware unit to which the row belongs. By clicking on the ID button, the corresponding hardware unit's front panel will illuminate. Each hardware unit is assigned a Peripheral Prefix which is displayed on the ID button.
2. **Setting Sample Rate** - This drop down selects the sample rate. Under certain circumstances, (for example, when a DAW session is open) this setting will be overridden by software sample rate settings.
3. **Peak Hold** - This pop-up menu sets the time that peak indications are held on software and front panel meters.
4. **Over Hold** - This pop-up menu sets the time that over indications are held on software and front panel meters.
5. **Keyboard Volume Control** - The Audio Output drop down menu sets the hardware output that's controlled by the Mac keyboard volume control.

## Maestro Menu Bar

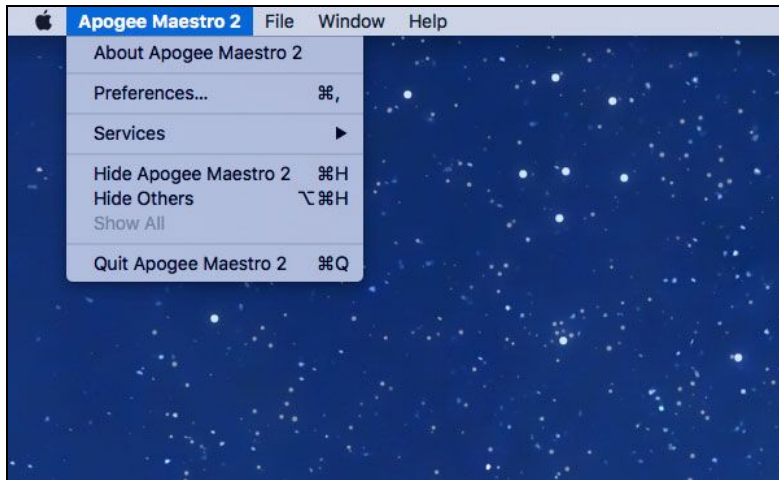

**About Apogee Maestro** - Choose this menu item to display version information.

**Preferences** - Choose this menu item to display Maestro's Preference panel.

Check Launch Maestro automatically when connecting a device to launch Maestro when the Mac is started. Check Display Pop-ups to show top panel encoder adjustments.

**Hide Apogee Maestro 2** - Choose this menu item to hide the Maestro application.

**Hide Others** - Choose this menu item to hide all other open applications.

**Show All** - If any open applications have been hidden, choose this menu item to reveal all open applications.

**Quit Apogee Maestro 2** - Choose this menu item to quit Maestro.

## File Menu

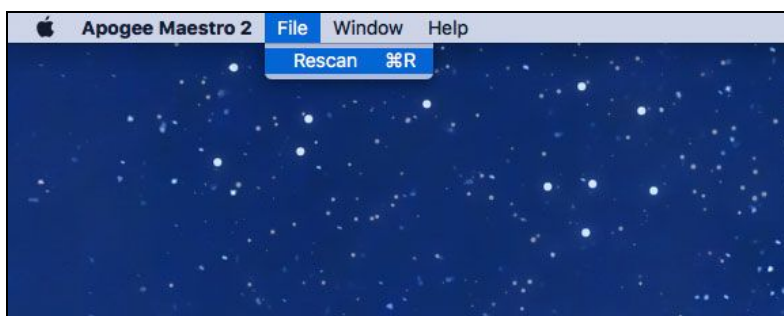

**Rescan** - Choose this menu item to re-initialize the link between Maestro software and Apogee hardware connected to the Mac, in the case where the hardware is correctly connected and powered on but not detected in Maestro.

## Window Menu



**Minimize** - Choose this menu item to minimize the Maestro window to the OS X Dock.

**Zoom** - Choose this menu item to maximize the size of the Maestro window.

Open any of the currently active tabs by typing Command + number.

## Help Menu

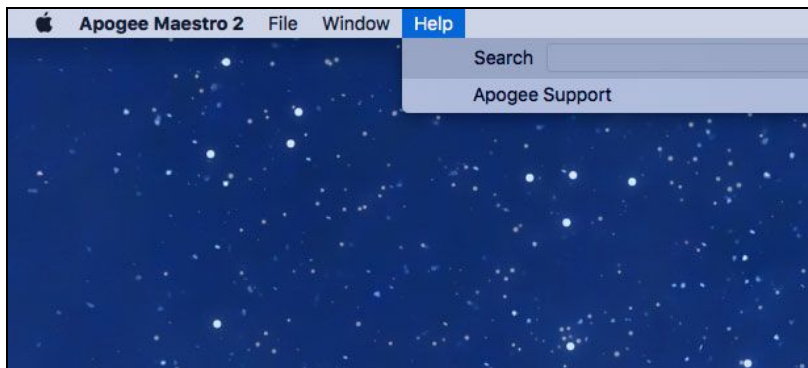

**Help** - Choose this menu item to open Maestro Help for any Apogee hardware devices connected to your Mac.

## iOS Main Menu

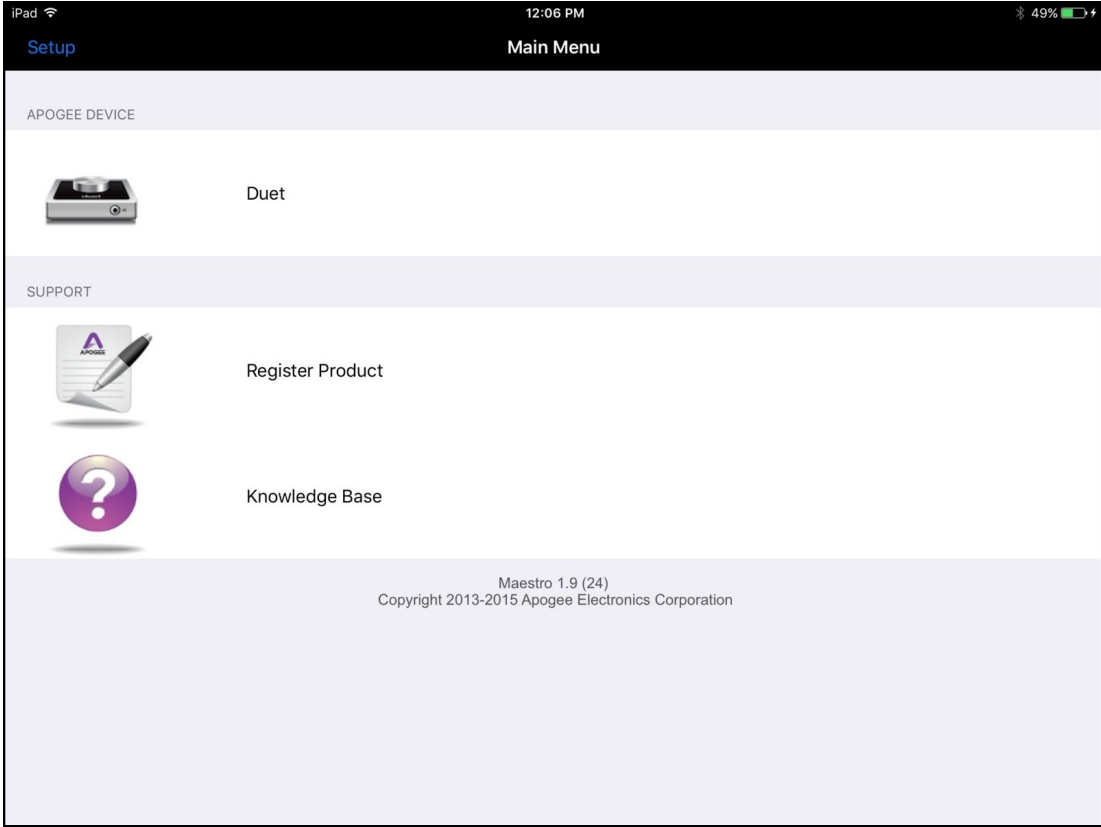

**Apogee Device** - Select device in use to access Maestro tab windows.

**Register Product** - Please register your Apogee Duet for free technical support and to receive product updates and notifications via email.

**Knowledge Base** - The Apogee KnowledgeBase is your number one resource for Frequently Asked Questions regarding your Duet. If you have a question, search the KnowledgeBase. If your question has not been answered, please contact technical support.



# Operation

## Configuring the Input

### Mac

1. Connect your input source ([see analog inputs section](#))
2. Open Apogee Maestro software (found in your Mac's Applications folder), and select the Input tab.
3. Select the Analog Level setting that corresponds to the device you have connected to Duet's input(s).



**+4 dBu:** XLR line level

**-10 dBV:** XLR line level

**Mic:** XLR microphone (dynamic, condenser or ribbon)

**Inst:** 1/4" Instrument (electric guitar, bass, keyboards)

4. If you are using a condenser microphone that requires phantom power, select the 48V box on the Input tab of the appropriate channel in Maestro. Phantom power is indicated on Duet's display by a red dot above the microphone icon.



48V Phantom power button in Maestro

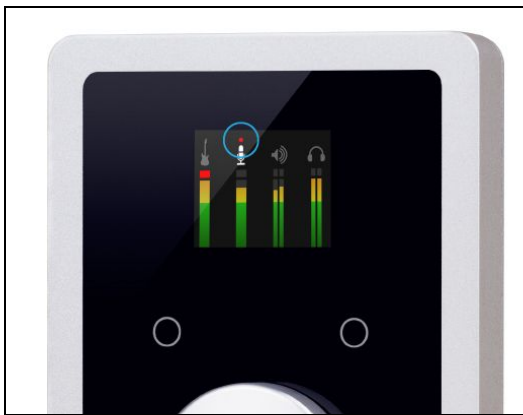

48V Phantom power indicator on OLED Display

## iPad

1. Connect your input source ([see Analog Inputs Section](#))
2. Open Apogee Maestro app, choose Duet from the main menu and select the Input tab.

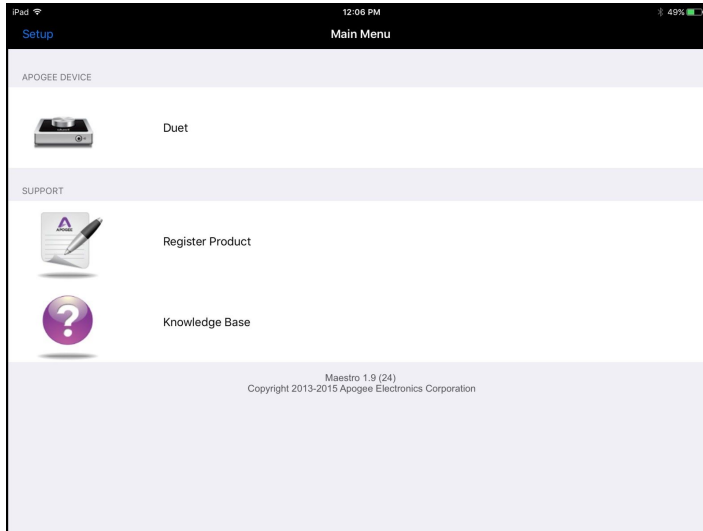

3. Select the Analog Level setting that corresponds to the device you have connected to Duet's input(s).

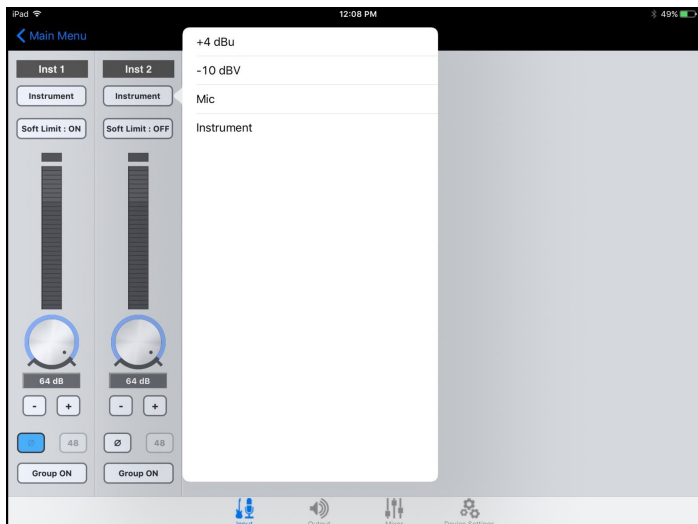

**+4 dBu:** XLR line level

**-10 dBV:** XLR line level

**Mic:** XLR microphone (dynamic, condenser or ribbon)

**Inst:** 1/4" Instrument (electric guitar, bass, keyboards)

4. If you are using a condenser microphone that requires phantom power, select the 48V box on the Input tab of the appropriate channel in Maestro. Phantom power is indicated on Duet's display by a red dot above the microphone icon.

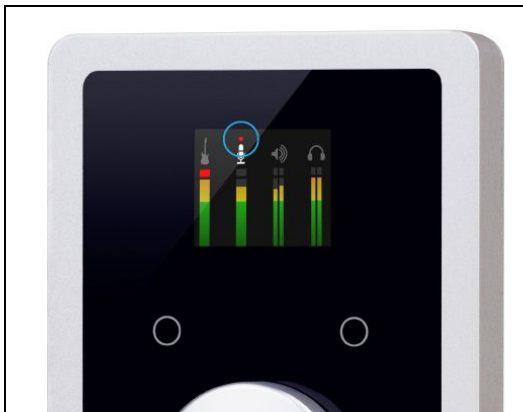

48V Phantom power indicator on OLED Display

## Configuring the Output

### Speaker Output Level - Mac

1. Connect Duet to the Mac.
2. Open Apogee Maestro software (found in your Mac's Applications folder), and select the Output tab.
3. Go to Speaker Output drop down menu and select your Output source for desired playback (1-2, 3-4 or Mixer). 1-2 is usually the default Output source on most recording software.

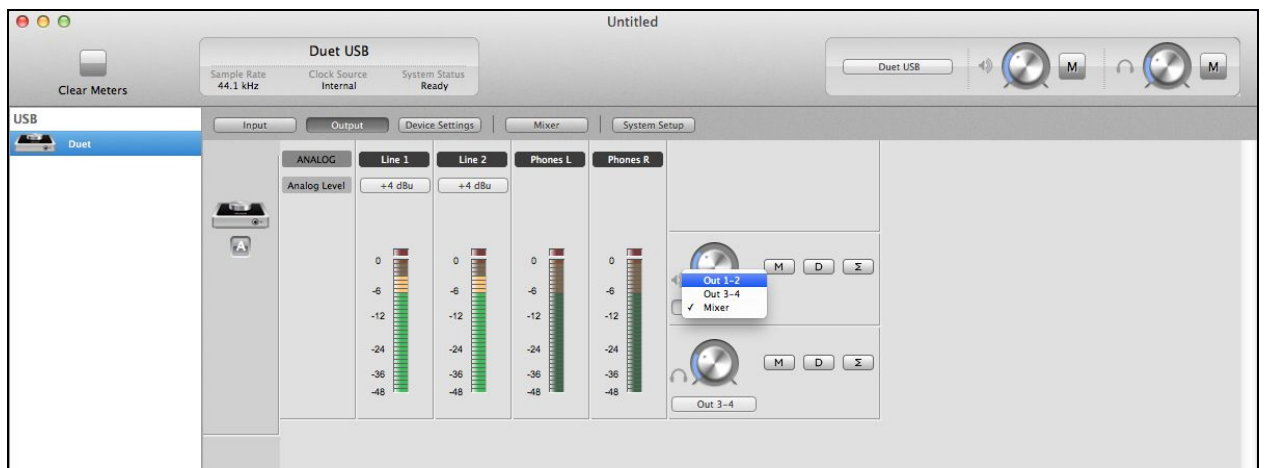

## Headphone Output Level - Mac

To change Duet's headphone output level (i.e the listening level of connected headphones):

1. Connect Duet to the Mac.
2. Open Apogee Maestro software (found in your Mac's Applications folder), and select the Output tab.
3. Go to Headphone Output drop down menu and select your Output source for desired playback (1-2, 3-4 or Mixer). 1-2 is usually the default Output source on most recording software.

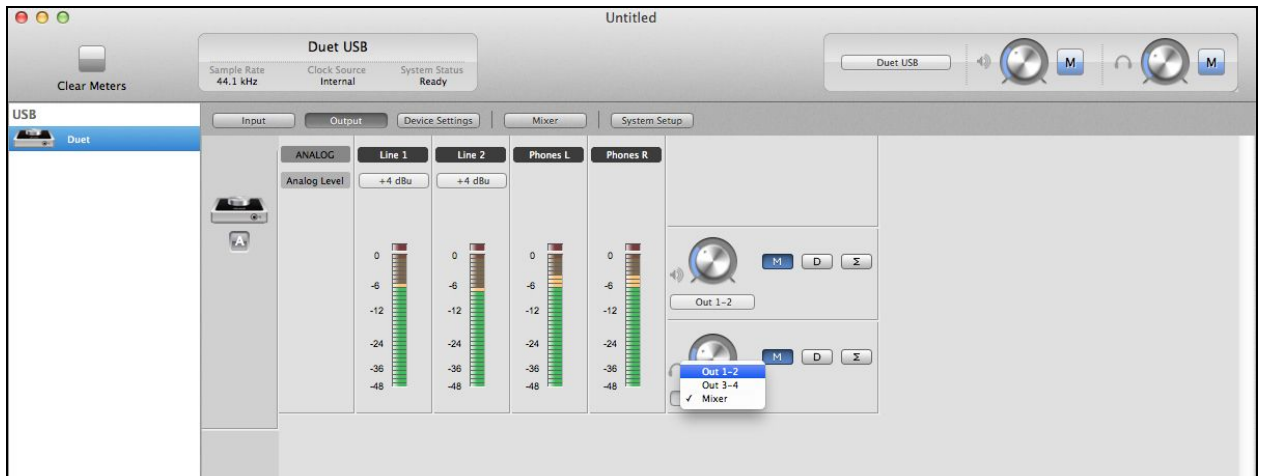

## Speaker Output Level - iPad

1. Connect Duet to the iPad.
2. Open Apogee Maestro app, choose Duet from the main menu and select the Output tab.

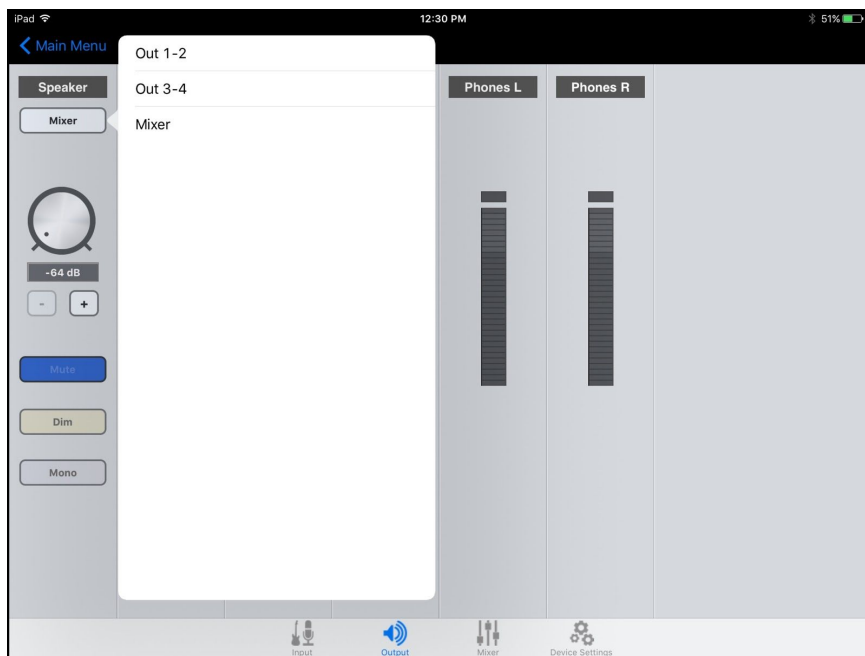

3. Go to Speaker Output drop down menu and select your Output source for desired playback (1-2, 3-4 or Mixer). 1-2 is usually the default Output source on most recording apps.

## Headphone Output Level - iPad

To change Duet's headphone output level (i.e the listening level of connected headphones):

1. Connect Duet to the iPad.
2. Open Apogee Maestro app, choose Duet from the main menu and select the Output tab.



3. Go to Headphone Output drop down menu and select your Output source for desired playback (1-2, 3-4 or Mixer). 1-2 is usually the default Output source on most recording apps.



## Adjusting Input & Output Levels

Levels can be adjusted from hardware or software

The controller knob operates in parallel with Maestro's speaker and headphone control.



### Input level

To change Duet's input level (i.e the preamp gain of microphones and instruments):

1. Push the Multi-function Controller Knob until the microphone or instrument icon is lit on the Duet's display.

If you are using +4dB or -10dBV Line Levels, no input gain level control is provided since it's a fixed input level and the Mic Preamps are bypassed.

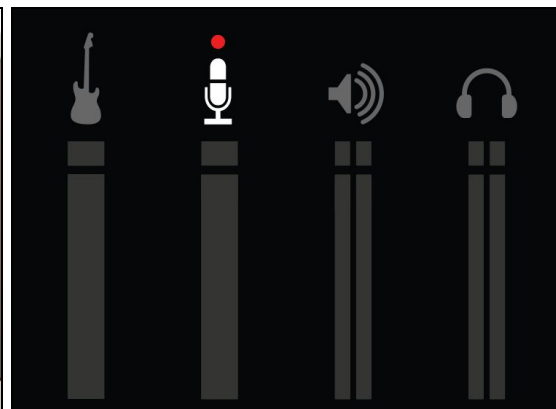

2. Turn the Controller Knob until the desired recording level is obtained.

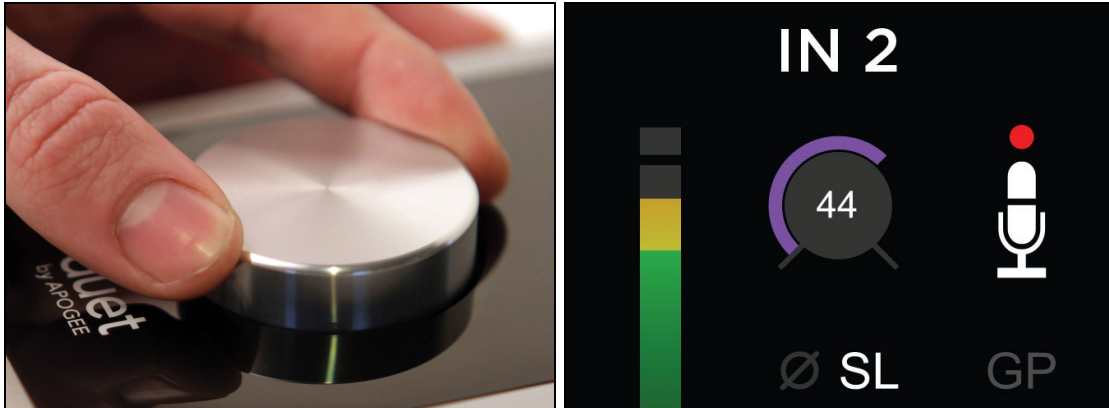

## Speaker Output level

To change Duet's speaker output level (i.e the listening level of connected speakers):

1. Push the Multi-function Controller Knob until the speaker icon is lit on the Duet's display

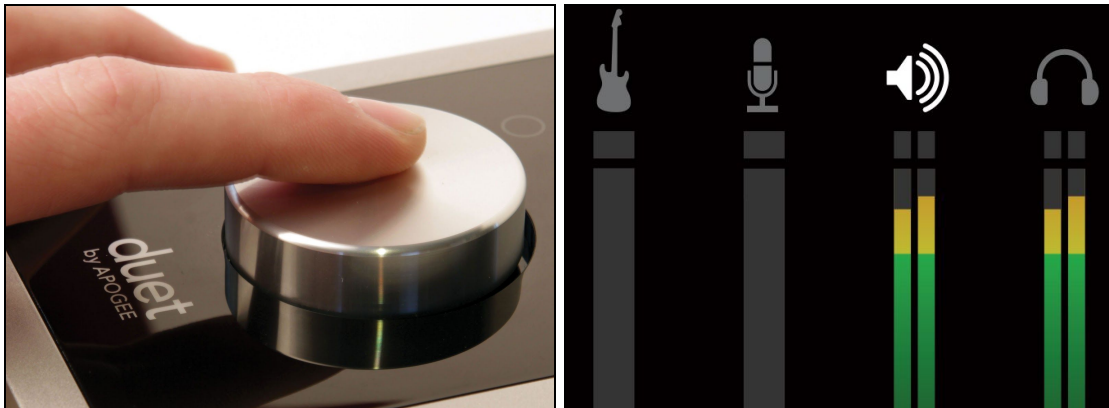

2. Turn the controller knob to the desired listening level.

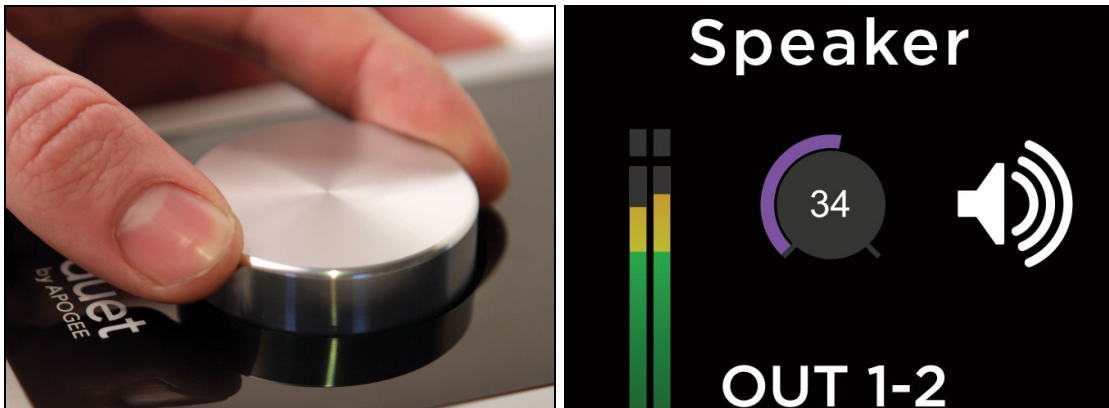

## Headphone Output level

To change Duet's headphone output level (i.e the listening level of connected headphones):

1. Push the Multi-function Controller Knob until the headphone icon is lit on the Duet's display

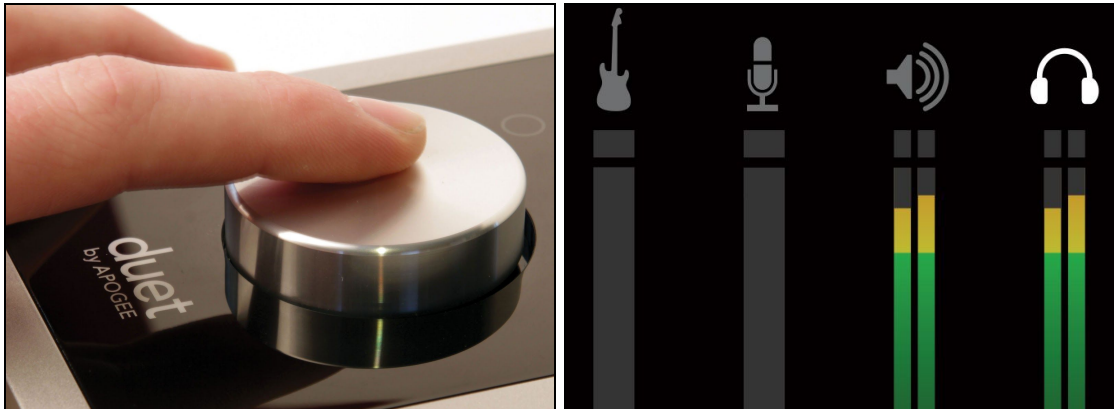

2. Turn the controller knob to the desired listening level.

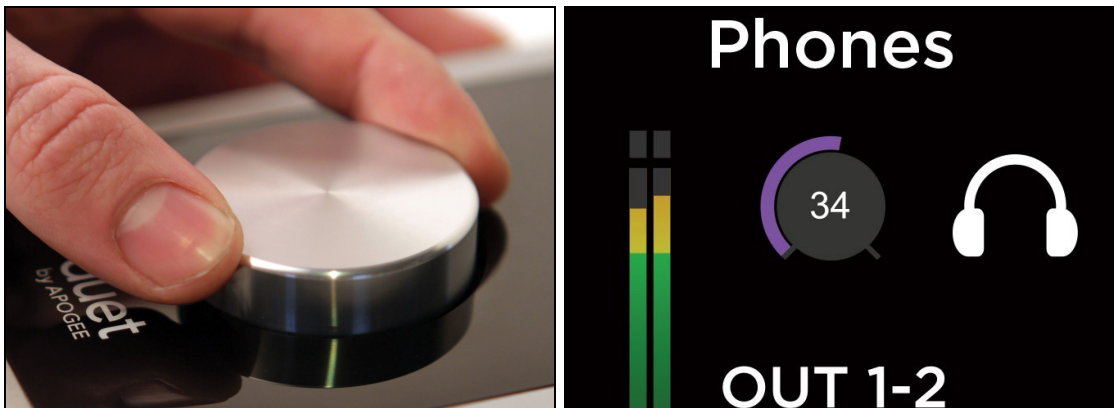

## Low Latency Mixing

While recording, if you notice a delay between the moment you play or sing a note and when you hear it in your headphones you are experiencing latency. To minimize this latency, instead of using your recording software's monitoring features, you can use the hardware monitor system built into Duet:

### How to configure Low Latency Mixer

1. Once all inputs are set up, disable software monitoring in DAW.
2. Go to Output Tab in Maestro and choose Mixer under Speaker or Headphone Out selection.

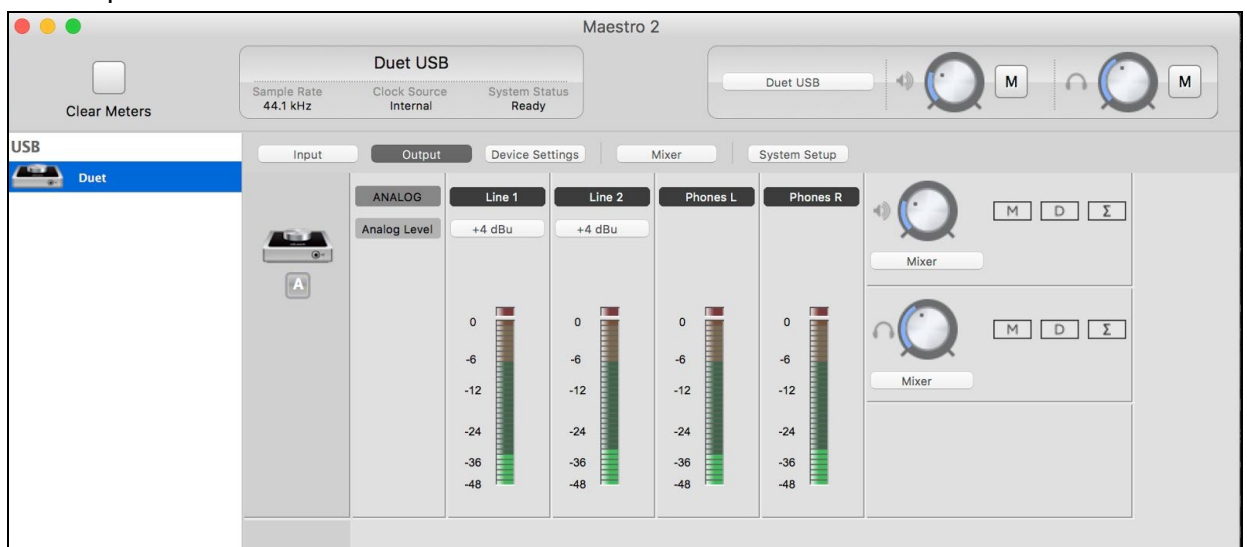

3. Input signal should be heard in Speakers or Headphones.

4. Go to Mixer Tab to control volume, mute and solo of input.

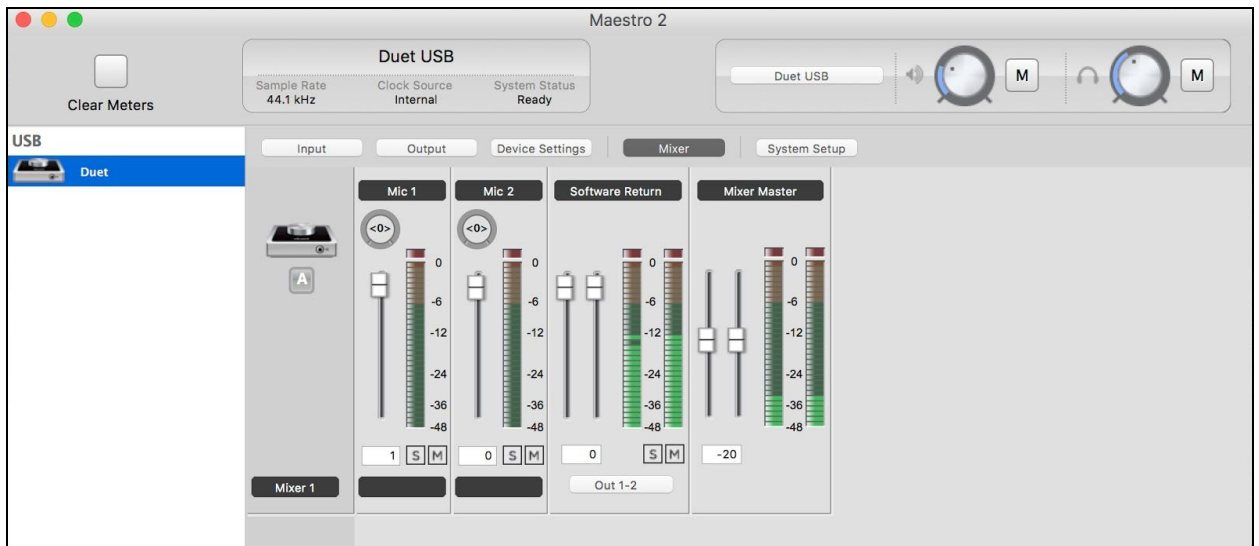

## Why use a Low Latency Mixer?

A bit of background information concerning latency and computer-based digital recording setups will help you better understand these functions.

When recording with most computer-based digital audio applications, the delay between the input and output of the recording system often disturbs the timing of the musicians performing. This delay, known as latency, means that the musician hears the notes played a few milliseconds after having actually played them. As anyone who has spoken on a phone call with echo knows, relatively short delays can confuse the timing of any conversation, spoken or musical.

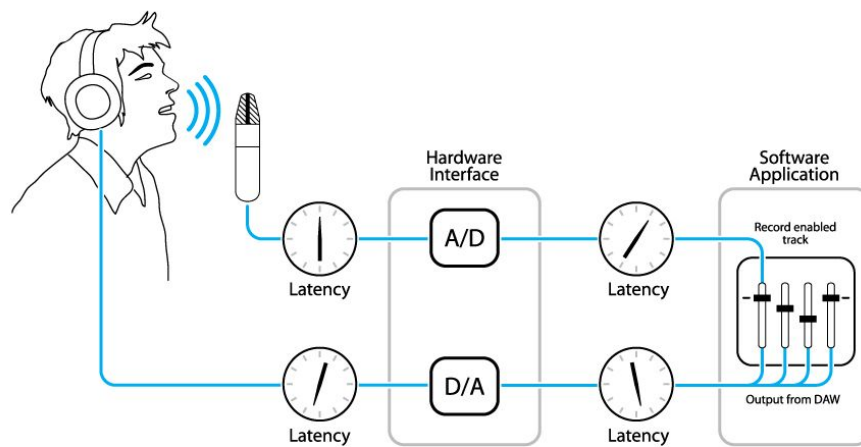

**Figure A**

To illustrate the effect of latency, **Figure A** depicts the typical signal path of a vocal overdub session. A vocalist sings into a microphone, which is routed to an analog to digital converter, then to the audio software application for recording. In the software application, the vocalist's live signal is mixed with the playback of previously recorded tracks, routed to a digital to analog converter, and finally to the vocalist's headphones. A slight delay accumulates at each conversion stage, while a much greater amount of delay occurs through the software application, resulting in the vocalist hearing his performance in headphones delayed by several milliseconds.

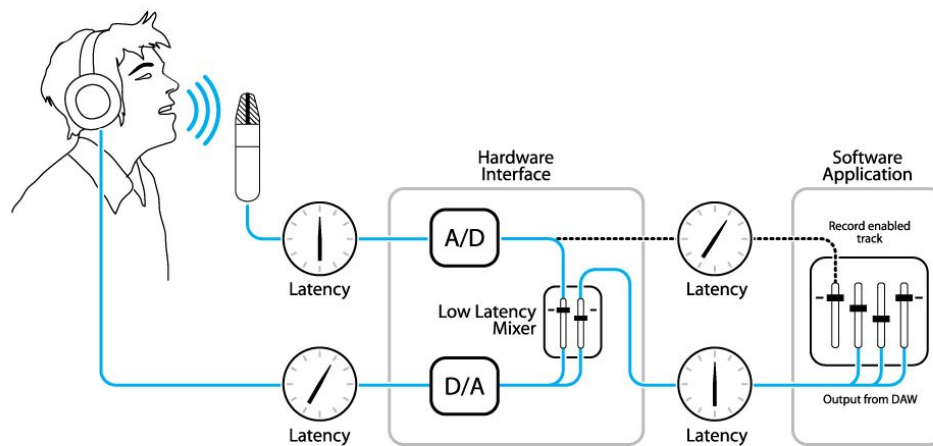

**Figure B**

By routing the hardware input directly to the hardware output and mixing in playback as shown in Figure B, it's possible to provide the vocalist a headphone monitoring signal with a much shorter delay. First, the signal being recorded (in this case, a vocal mic) is split just after the A/D stage and routed to both the software application for recording and directly back to the hardware outputs without going through the latency-inducing software. This creates a low latency path from mic to headphones. Next, a stereo mix of playback tracks is routed to the low latency mixer and combined with the hardware input(s). This allows the performer to hear himself while listening to playback tracks without a confusing delay in order to comfortably record overdubs.

Note that the software application's mixer is used to set a stereo mix of playback tracks while the low latency mixer is used to set the balance between the stereo playback mix and the hardware inputs.



## Setting Sample Rate

Duet operates at all standard sample rates between 44.1 kHz and 192 kHz. In most cases, the sample rate is set by the audio application with which Duet is communicating. For example, when using Duet with GarageBand, Duet's sample rate is automatically set to 44.1 kHz, to match the GarageBand Song sample rate. For those audio applications that don't include a sample rate setting such as iTunes, Duet's sample rate may be set in Audio MIDI Setup or on the System Setup tab of Maestro.

## Touchpads

The 2 touchpads, located on either side of the encoder knob, allow you to quickly access output functions such as "Mute Outputs", "Dim Outputs", "Sum to Mono" or "Toggle Headphone Source". Each are assignable using a drop-down menu within Apogee Maestro. This unique feature allows you to select the function you want and access it directly from Duet without having to look at software. Touchpads on Duet will be set by default to Mute all Outputs and Clear Meters.

## Changing Touchpad Assignments

### Mac

1. Connect Duet to the Mac.
2. Open Apogee Maestro software (found in your Mac's Applications folder), and select the Device Settings tab.
3. Select either touchpad A or B drop down menu and select the desired assignment.

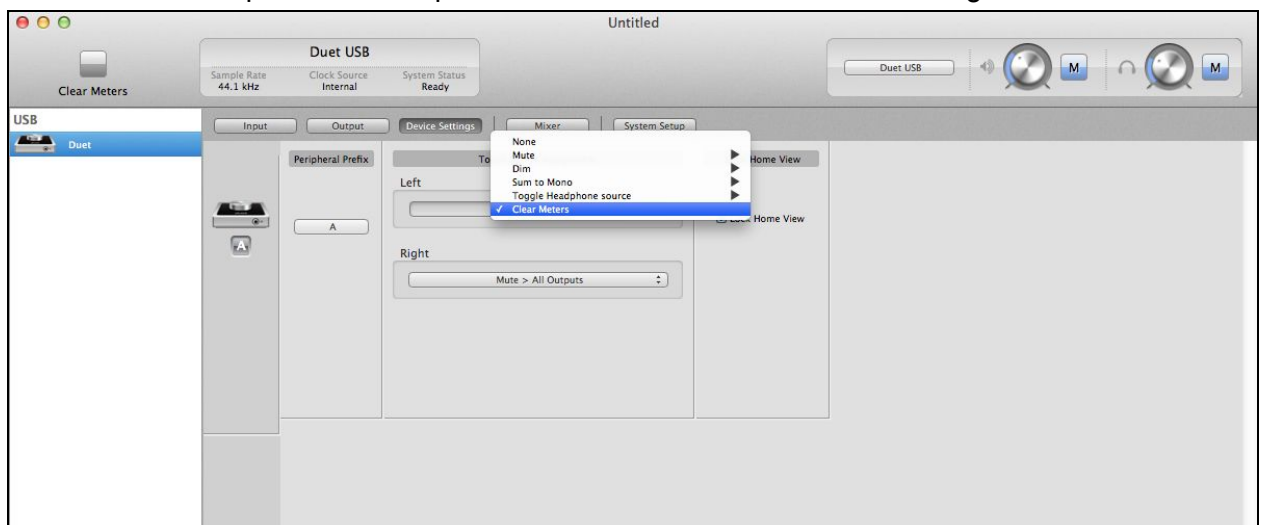



iPad

1. Connect Duet to the iPad.
2. Open Apogee Maestro app, choose Duet from the main menu and select the Device Settings tab.
3. Select either touchpad A or B drop down menu and select the desired assignment.

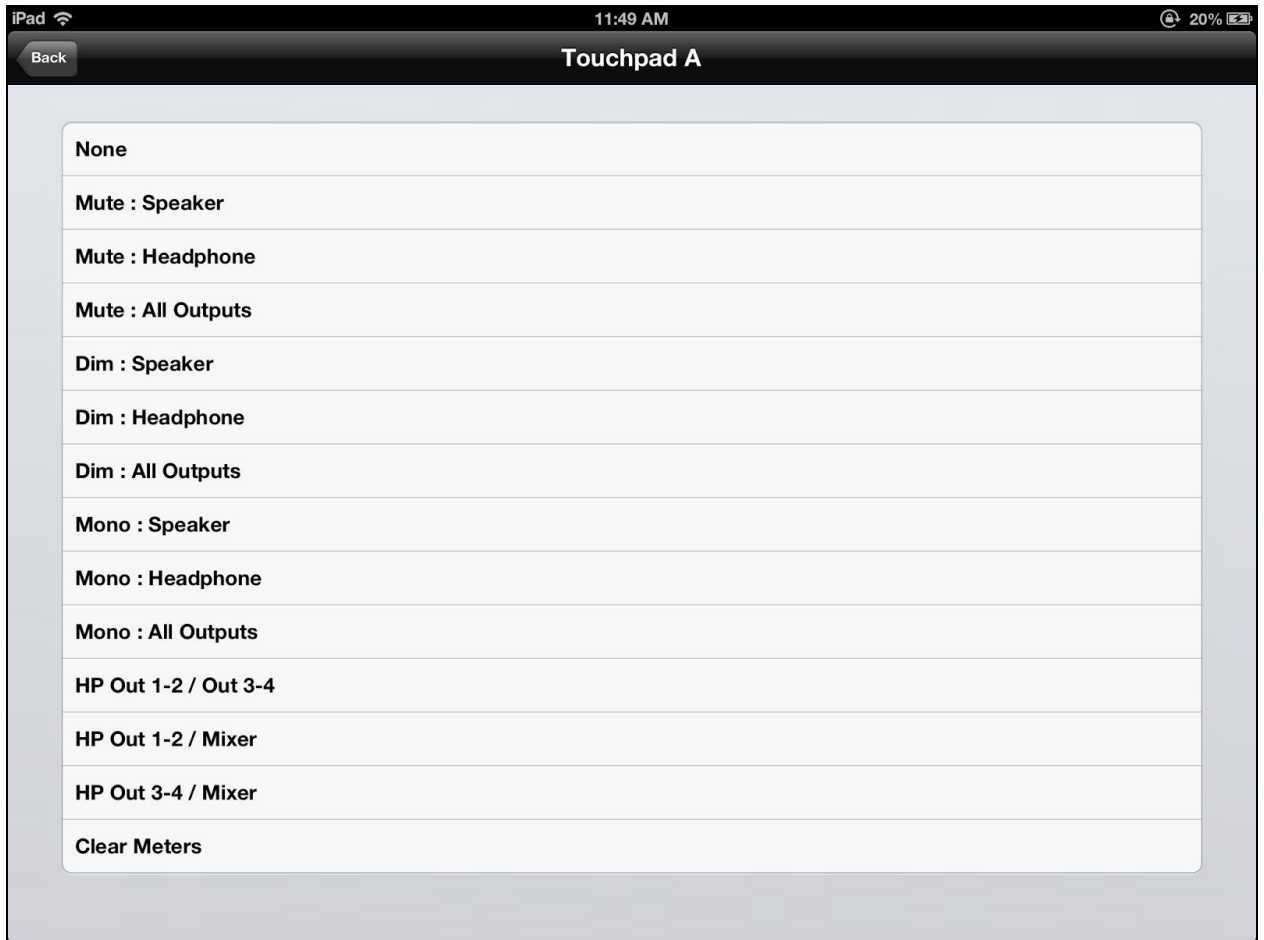

# Software Setup

## Mac OS: Using Duet with Logic

1. Go to the Logic Pro or Logic Express menu and choose **Preferences > Audio**.

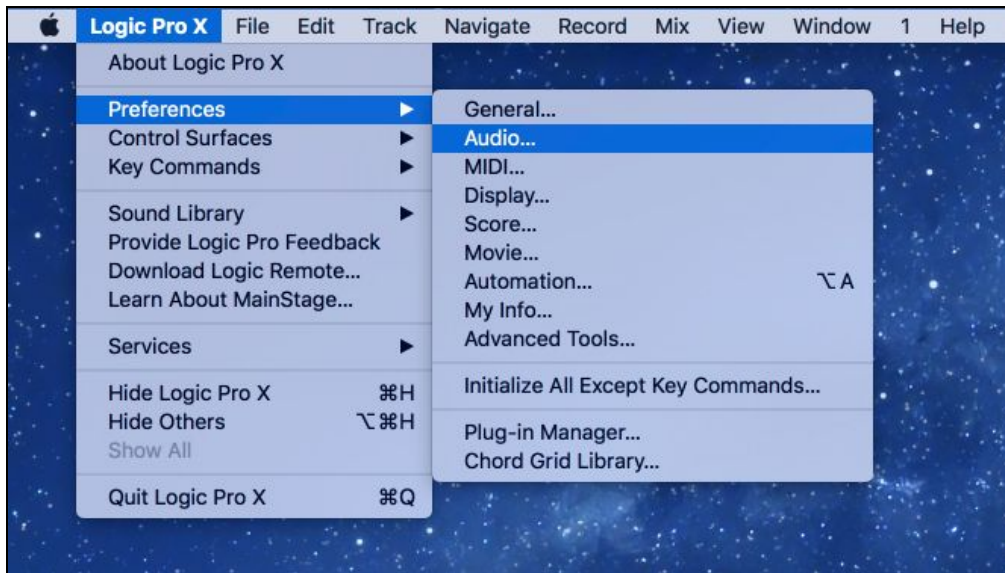

2. In the Core Audio pane of the Device tab, select Duet for Output Device and Input Device.

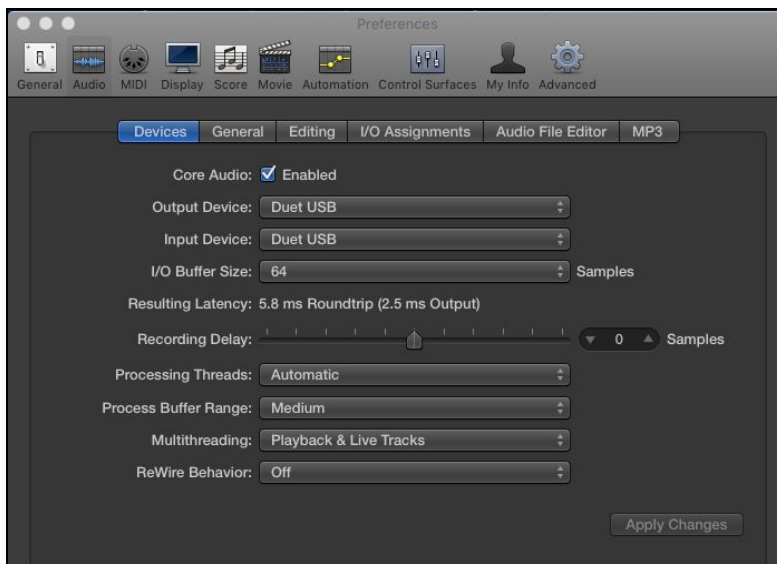

3. Set the I/O Buffer Size to 64. This setting may need to be adjusted based on your computer's performance. Click Apply Changes at the bottom of the Preferences window.

- Now close the Logic Pro Preferences window and select **New > Empty Project >** from the File Menu.

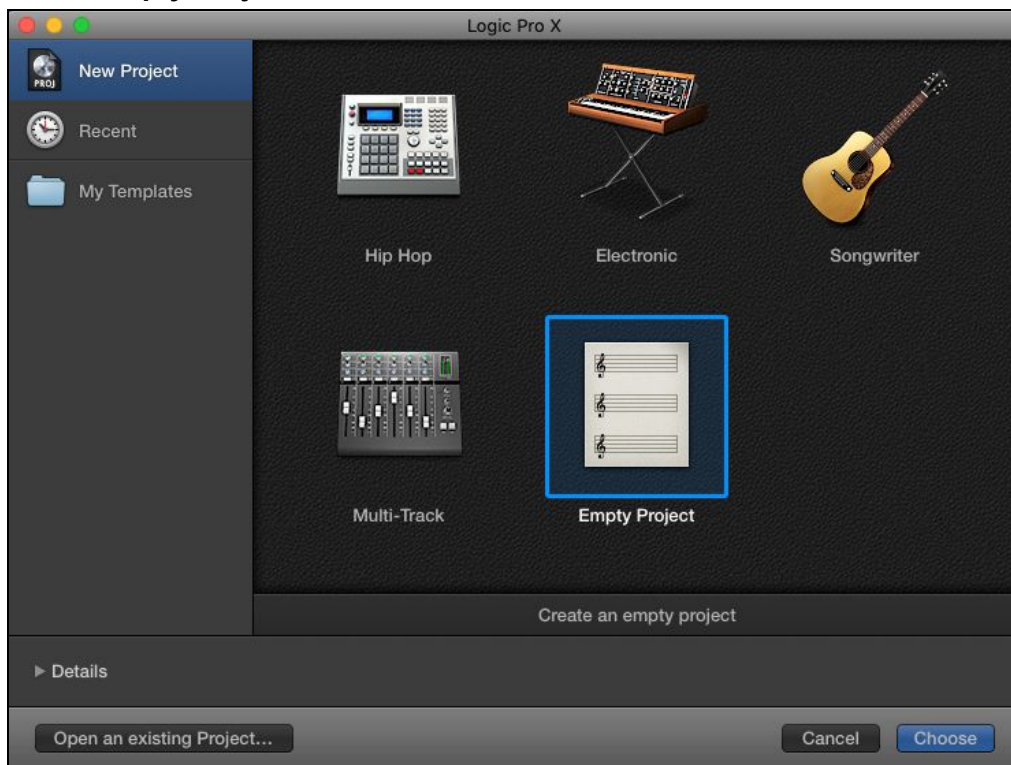

- If you are recording a single microphone or instrument, make the following selections in the New Tracks dialog box and click Create:

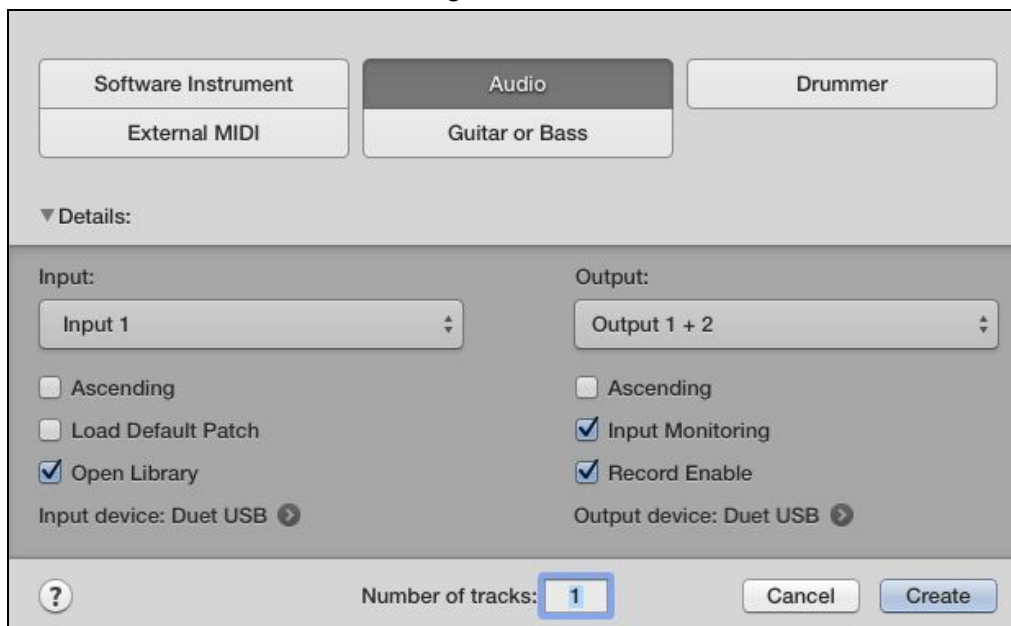

## Mac OS: Using Duet with Avid Pro Tools

1. Choose **Setup** menu > **Playback Engine**.

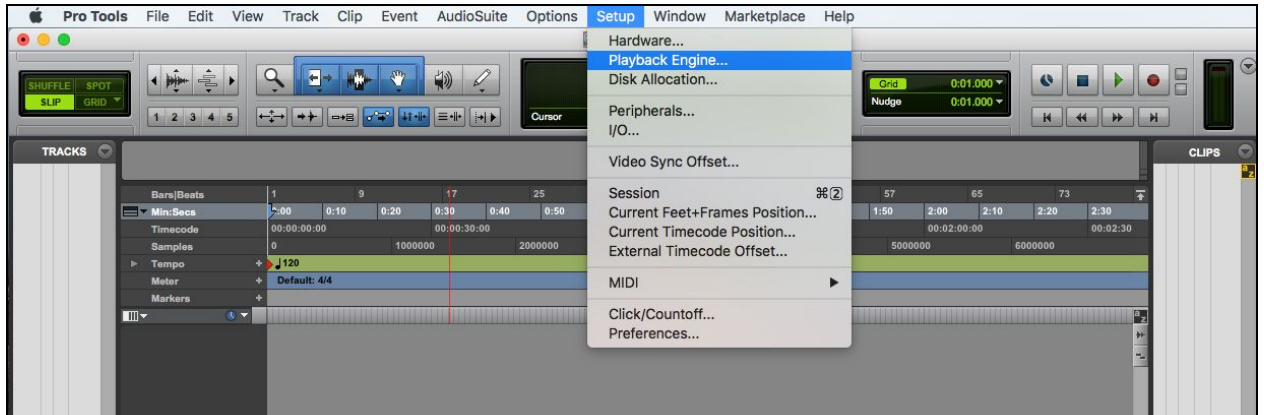

2. Choose **Duet USB** for **Current Engine**.

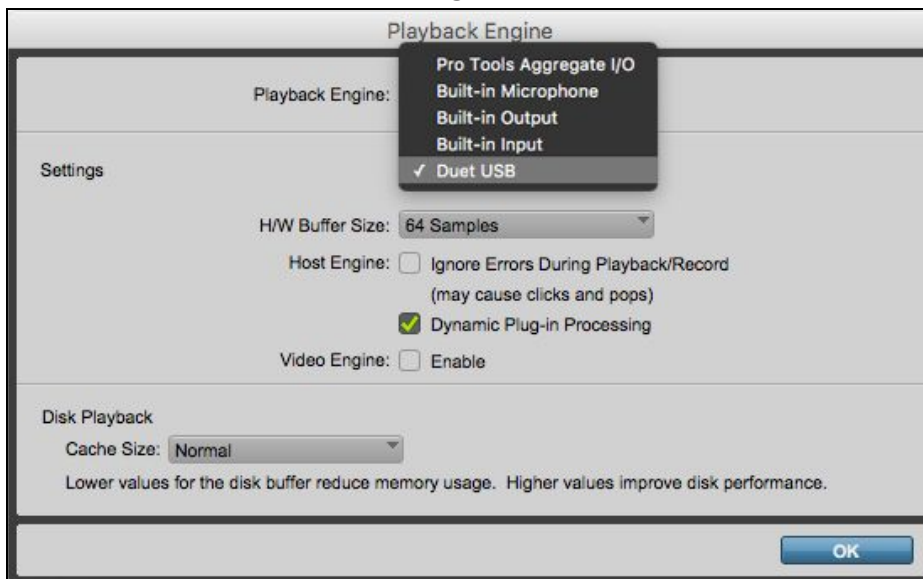

3. Set the H/W Buffer Size to 64 Samples. This setting may need to be adjusted based on your computer's performance. Click OK.
4. The following dialog box will appear. **Click Yes**.

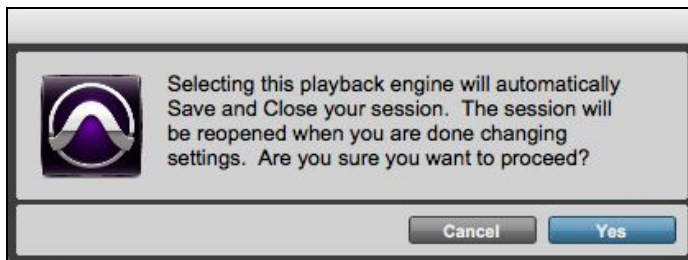

## Mac OS: Using Duet with Ableton Live

1. **Choose Live > Preferences.** Click on the Audio tab.
2. Select CoreAudio in the Driver Type menu.
3. Select Duet in both the Audio Input Device and Audio Output Device menus.
4. Set Buffer Size to 64 Samples. This setting may need to be adjusted based on your computer's performance.
5. Close the Preferences window after making settings.



## Using Duet with iOS Apps

Duet works with any iOS Core Audio compatible app on iPod Touch, iPhone or iPad. Simply download [Maestro for iOS](#), your favorite app, connect Duet and you're ready to go!

### GarageBand



1. Open Garageband and create a new song.

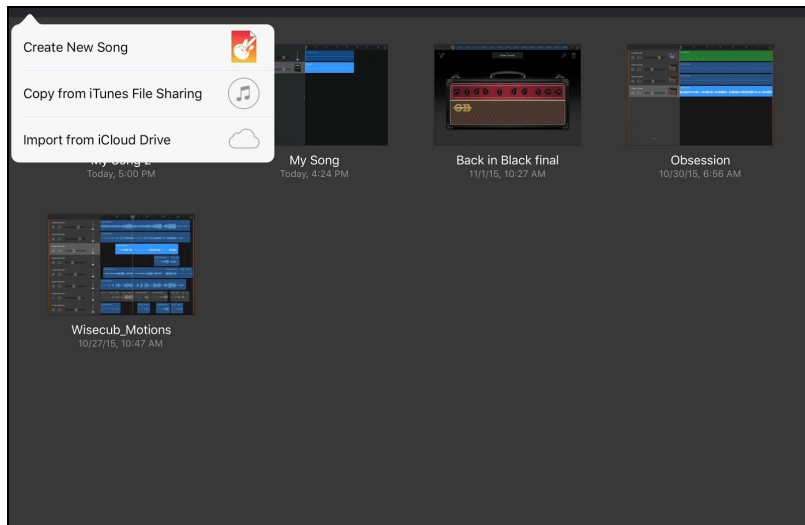

2. Select the instrument to be used.
  - Audio Recorder for Vocals
  - Amp for Guitar
  - Keyboard for your MIDI controller

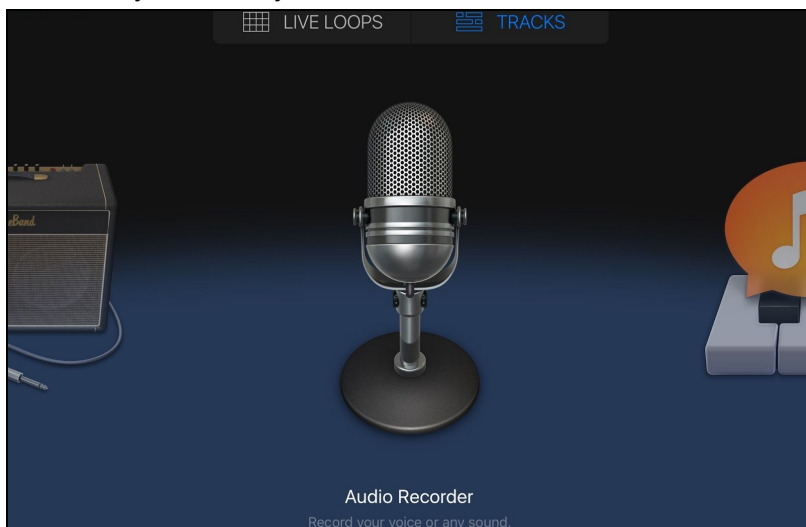

3. Go to Input Setting on the top left corner of the screen.

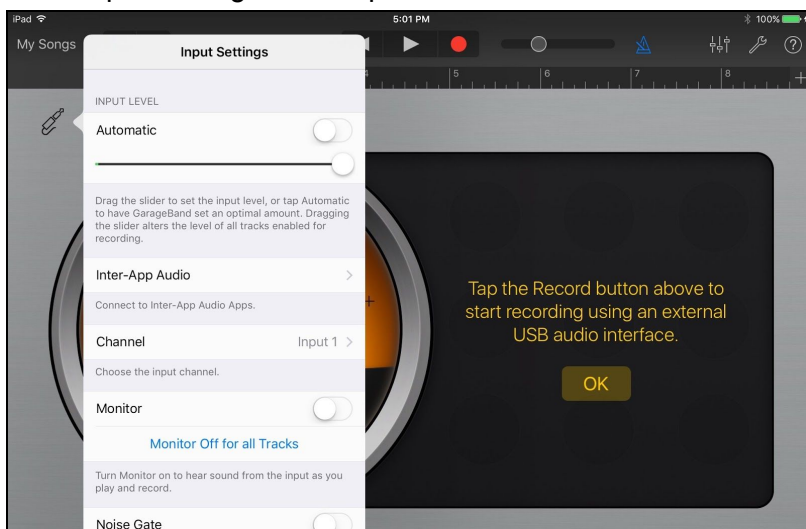



4. Select Input Channel 1

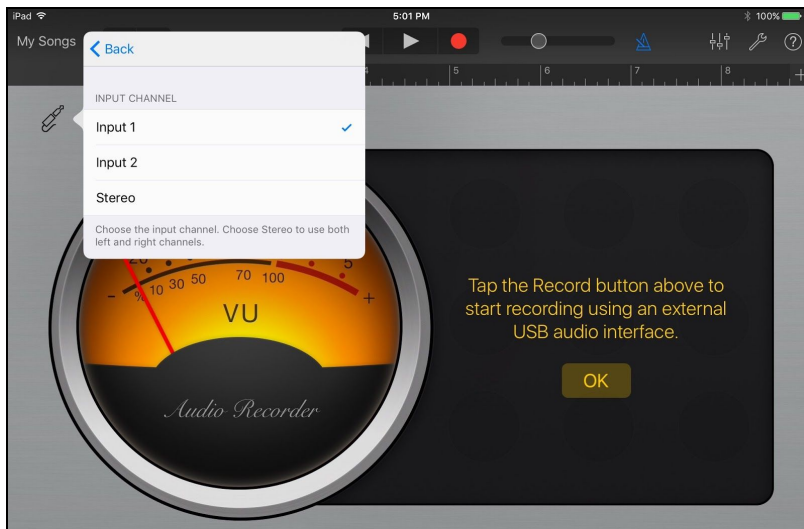

5. Set monitor to ON, Press Record on the top of the screen and you are ready to go!



If you are recording with a microphone that requires 48v Phantom power, please refer to the [Configuring the Input Section](#) of this User Guide.



If you would like to record two tracks at the same time, add and Select another instrument

- Audio Recorder for Vocals
- Amp for Guitar
- Keyboard for your MIDI controller

1. For this example select Amp

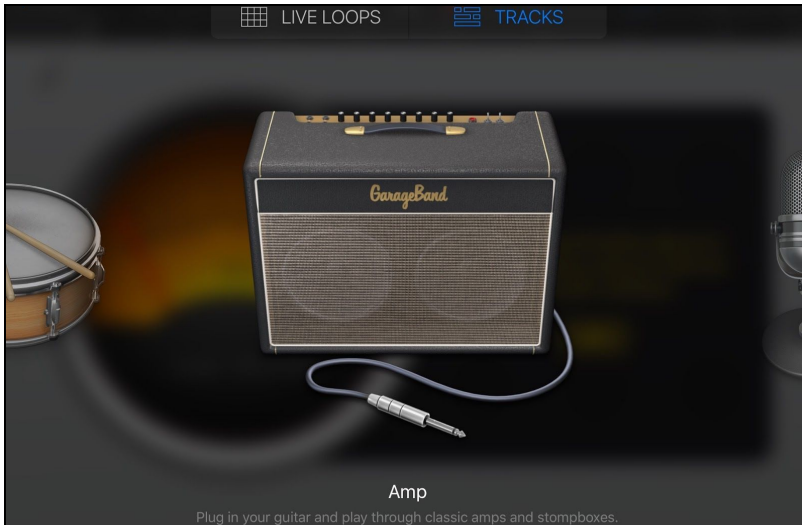

2. Go to Input Setting on the top left corner of the screen and select Input 2 then < Back

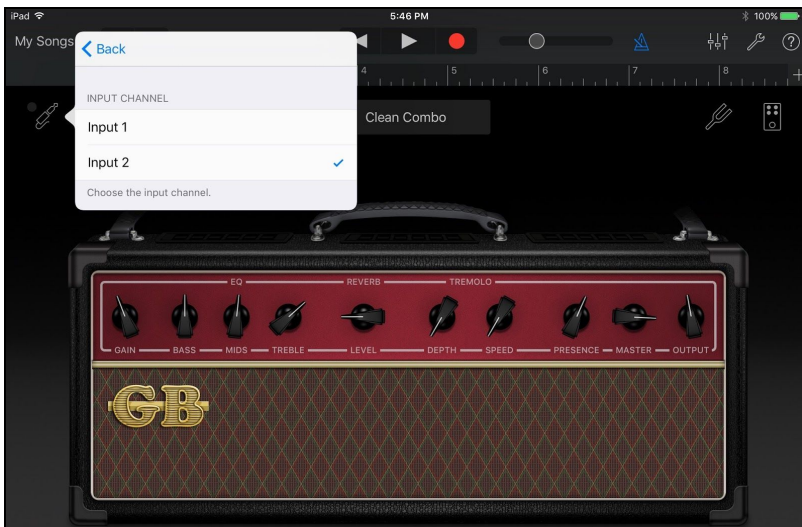

3. Make sure Monitor is turned on

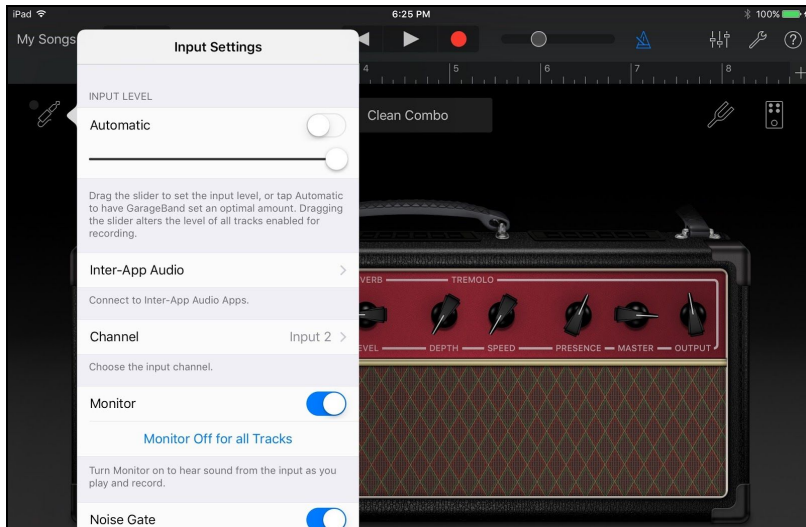

Enable recording on the two separate mono tracks simultaneously. We recommend you do this instead of creating a single stereo track so audio output is panned correctly.

4. Begin by touching the tracks view button. Then swipe right to expand the tracks controls.

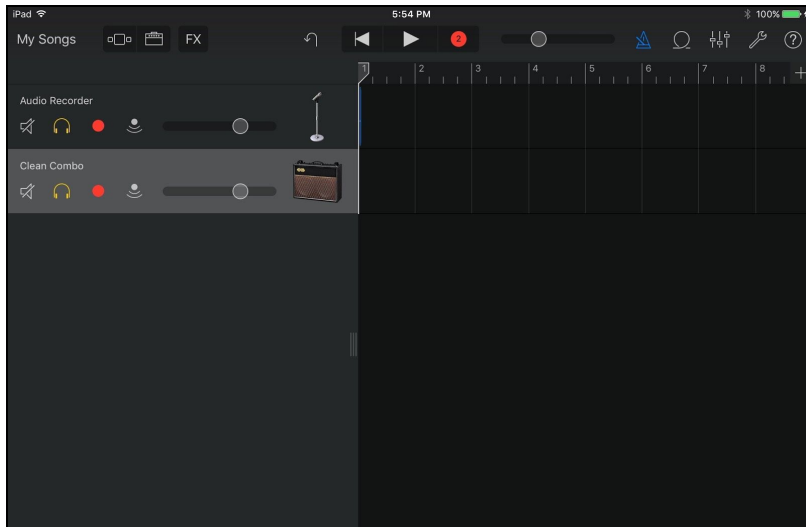

5. Make sure the red dot record arm button is selected for both tracks.

Now you are ready to record to both tracks simultaneously.

Auria



1. Open Auria App



2. Choose Menu > New Project. Select Sample Rate and number of tracks. Press Save.



3. Choose Menu > Input Matrix and make sure the input is going to the desired track.

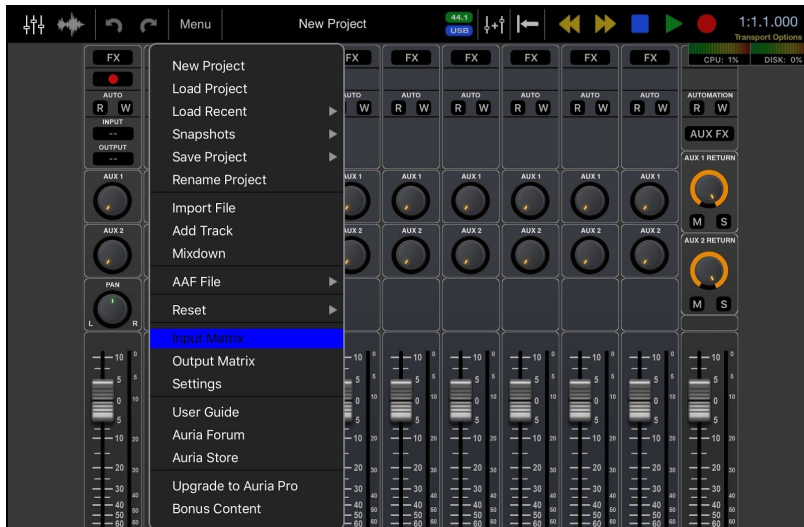

If you are recording with a microphone that requires 48v Phantom power, please refer to the [Configuring the Input Section](#) of this User Guide.

4. Set your input levels and Record enable the desired track.

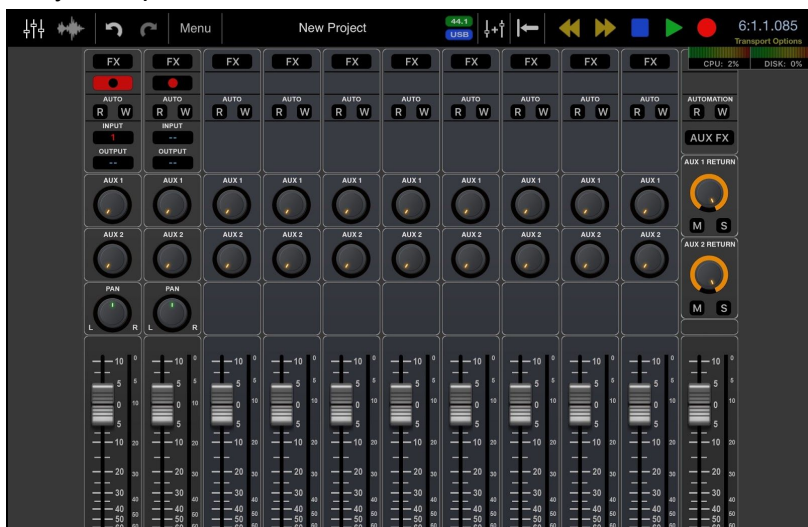

5. Press the Record button and then Play to start your recording.

# Cubasis



1. Open Cubasis app and create a New Project.

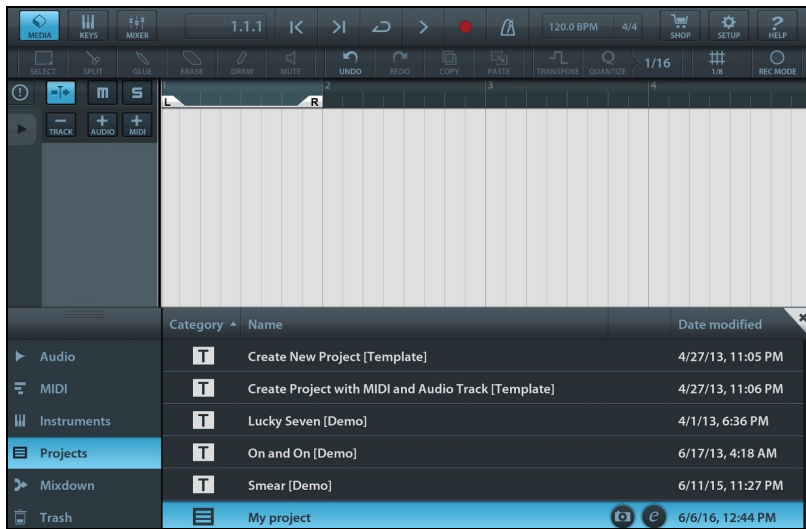

2. Add an Audio Track by touching the + Audio Button.

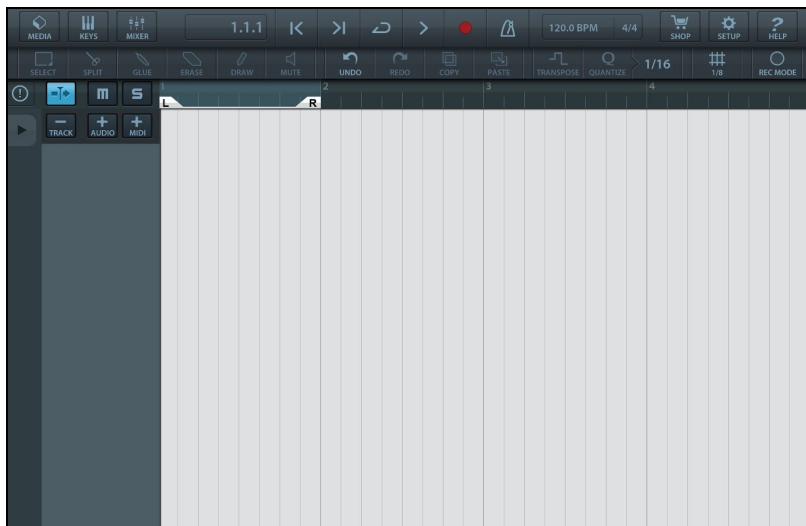

- Go to the Routing drop down Menu and select Mono input and your input source by tapping on the input channel number.

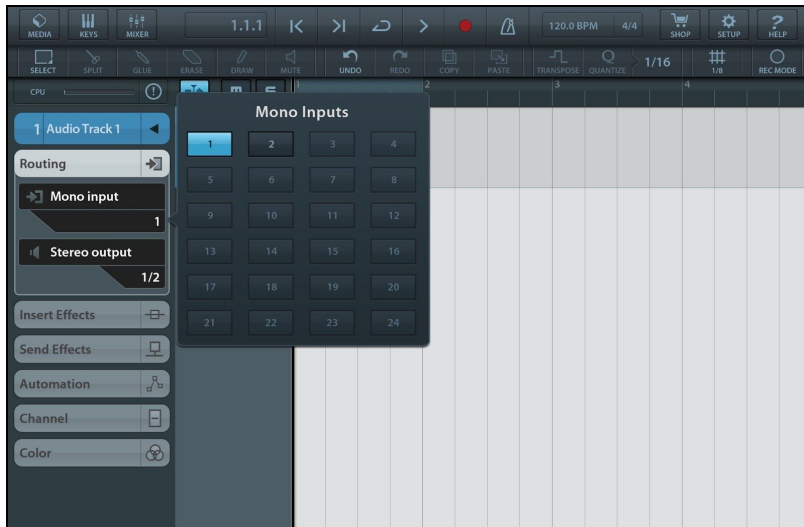

If you are recording with a microphone that requires 48v Phantom power, please refer to the [Configuring the Input Section](#) of this User Guide.

- Open the Mixer by pressing the Mixer button on top left corner of screen.

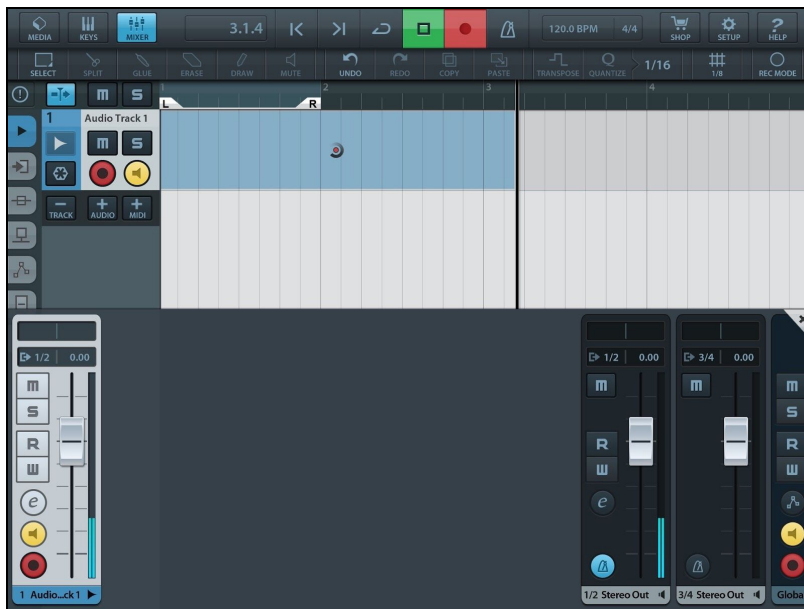

- Press Record Enable and Input Enable buttons on your channel and press Record.



Animoog



1. Connect Core MIDI device into the USB MIDI I/O port on the Duet Open Animoog.

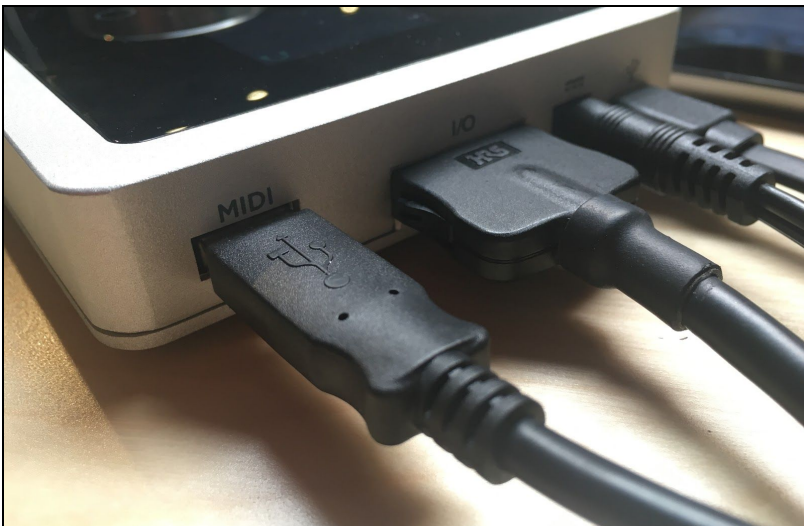



2. Choose > Setup > MIDI In and select Duet USB.



3. Press any key on your MIDI Keyboard to test.



4. Find your sound and play!

## Troubleshooting



### Looking for answers?

Ask the [www.apogeedigital.com/knowledgebase](http://www.apogeedigital.com/knowledgebase)

### Duet FAQs

**Q: I've connected my guitar, but I'm not getting any input. What should I check?**

A: On the Input tab of Maestro, be sure to set Analog Level to Instrument (Inst).

**Q: I'm not getting any output from audio software applications. What should I check?**

A: If you have chosen Mixer for the output then the Software Return fader must be raised to send audio software outputs to Duet's outputs.

**Q: I want Maestro to open automatically each time I connect Duet. What should I set?**

A: Open Maestro > Preferences and check the Launch Maestro automatically when connecting a device checkbox. (Only available on OS X)

**Q: How do I reset Duet?**

A: To reset Duet unplug the USB cable, hold down Controller knob, reconnect the USB cable and maintain the controller knob in the down position until the unit has completely initialized.

**Q: I am hearing a delay between what I play and what I hear in my headphones. Can I do anything about this?**

A: Using the low latency mixer found in the Apogee Maestro application may help. Click on the mixer tab to configure it to your desired settings. Be sure to set your desired output to "mixer" on the output page.

**Q: My Duet is not getting recognized by my iPad and it says not charging, what should I do?**

A: Make sure that your DC power cable is connected properly and in all the way, if this doesn't work try resetting the Duet.

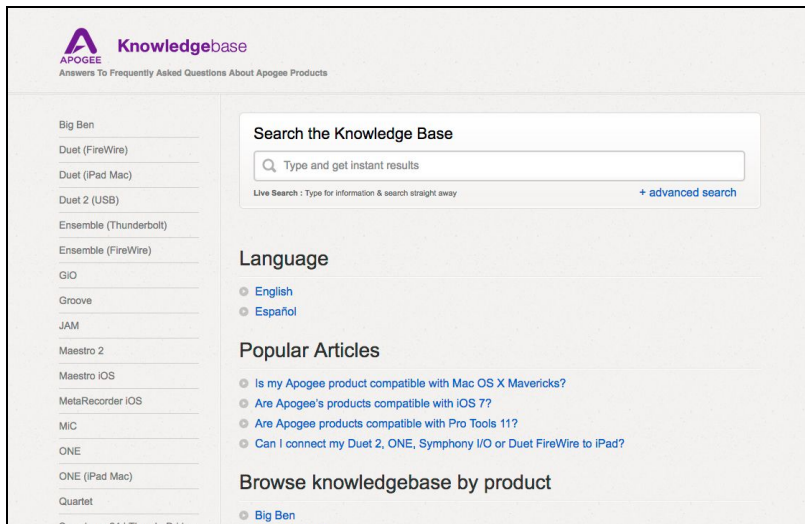

Visit [www.apogeedigital.com/knowledgebase](http://www.apogeedigital.com/knowledgebase) for the most up to date information.

## Additional Support

### For more information:

- Complete Apogee Duet User's Guide
- Apogee KnowledgeBase and FAQs
- Apogee Product Registration
- How to contact Apogee Technical Support

Visit: <http://www.apogeedigital.com/support/>

## Duet Specifications

Computer Connectivity	USB 2.0 High Speed
Roundtrip Latency performance	32 buffer @ 96kHz = 3.5 ms 64 buffer @ 44.1kHz = 4.2 ms
Power	USB Bus Power or DC power supply
Bit resolution/sample rate	24-bit/44.1-192kHz
Input Channels	2 Analog Inputs
Output Channels	2 Line/Speaker outputs + stereo headphone output
Speaker Outputs	Balanced
Independent Headphone Out	Yes
Microphone Preamps	2
Microphone Preamp Gain	up to 75dB
Line Level Input	+4 dBu, -10 dBV
OLED Display	Yes
Touch Pads	2 software assignable
Metering	Full Color OLED
Phantom Power	Yes
Phase Invert	Yes
Soft Limit	Yes
Group Inputs	Yes
Mute Outputs	Yes
Sum to Mono	Yes
Dim Outputs	Yes
Core Audio Compatible	Yes

# Warranty & Notifications

## Registration and Warranty Information

**To receive free tech support, important information and product updates first... Register your new Apogee product here:**

[www.apogeedigital.com/register/](http://www.apogeedigital.com/register/)

If you do so, Apogee can contact you with any update information. As enhancements and upgrades are developed, you will be contacted at the registration address. Firmware updates are free for the first year of ownership unless otherwise stated.

**APOGEE ELECTRONICS CORPORATION** warrants this product to be free of defects in material and manufacture under normal use for a period of 12 months. The term of this warranty begins on the date of sale to the purchaser (proof of purchase in the form of a receipt may be required). Units returned for warranty repair to Apogee or an authorized Apogee warranty repair facility will be repaired or replaced at the manufacturer's option, free of charge.

**ALL UNITS RETURNED TO APOGEE OR AN AUTHORIZED APOGEE REPAIR FACILITY MUST BE PREPAID, INSURED AND PROPERLY PACKAGED, PREFERABLY IN THEIR ORIGINAL BOX.**

Apogee reserves the right to change or improve design at any time without prior notification. Design changes are not implemented retroactively, and the incorporation of design changes into future units does not imply the availability of an upgrade to existing units. This warranty is void if Apogee determines, in its sole business judgment, the defect to be the result of abuse, neglect, alteration or attempted repair by unauthorized personnel. The warranties set forth above are in lieu of all other warranties, expressed or implied, and Apogee specifically disclaims any and all implied warranty of merchantability or of fitness for a particular purpose. The buyer acknowledges and agrees that in no event shall the company be held liable for any special, indirect, incidental or consequential damages, or for injury, loss or damage sustained by any person or property, that may result from this product failing to operate correctly at any time.

## Warranty Exclusions

- Used products purchased through a third party or online.
- Products with missing or defaced serial numbers.
- Products damaged by environmental factors, such as oxidation and/or damages caused by natural disaster.
- Units that have **NOT** been opened by user within the one year warranty period.
- Physical Damages which include, but not limited to the following:
- Unauthorized modifications
  - Misuse, neglect or improper assembly

- Transport damages due to improper packaging or carrier
- Burns resulting from faulty or failed electric power
- Missing/bent parts
- Cracked components
- Liquid/water damage

**USA:** Some states do not allow for the exclusion or limitation of implied warranties or liability for incidental or consequential damage, so the above exclusion may not apply to you. This warranty gives you specific legal rights, and you may have other rights which vary from state to state.

### **Service Information**

Your Apogee product contains no user-serviceable components; refer to qualified service personnel for repair or upgrade. Your warranty will be voided if you tamper with the internal components. If you have any questions with regard to the above, please contact Apogee.

In the event your Apogee product needs to be upgraded or repaired, it is necessary to contact Apogee prior to shipping, and a Return Merchandise Authorization (RMA) number will be assigned.

### **Warnings**

#### **FCC warning**

This equipment has been tested and found to comply with the limits for a Class A digital device, pursuant to Part 15 of the FCC rules. These limits are designed to provide reasonable protection against harmful interference when operated in a commercial environment. This equipment generates, uses, and can radiate radio frequency energy and, if not installed and used in accordance with the instruction manual, may cause harmful interference to radio communications. Operation of this equipment in a residential area is likely to cause harmful interference, in which case the user will be required to take whatever measures necessary to correct the interference at his own expense.

#### **Copyright Notice**

Duet is a computer-based device, and as such contains and uses software in ROMs. This software, and all related documentation, including this User's Guide contain proprietary information which is protected by copyright laws. All rights are reserved. No part of the software and its related documentation may be copied, transferred, or modified. You may not modify, adapt, translate, lease, distribute, resell for profit or create derivative works based on the software and its related documentation or any part thereof without prior written consent from Apogee Electronics Corporation, U.S.A.

#### **Software Notice**

Redistribution and use in source and binary forms, with or without modification, are permitted provided that the following conditions are met:

1. Redistributions of source code must retain the above copyright notice, this list of conditions and the following disclaimer.

2. Redistributions in binary form must reproduce the above copyright notice, this list of conditions and the following disclaimer in the documentation and/or other materials provided with the distribution.

THIS SOFTWARE IS PROVIDED BY THE COPYRIGHT HOLDERS AND CONTRIBUTORS "AS IS" AND ANY EXPRESS OR IMPLIED WARRANTIES, INCLUDING, BUT NOT LIMITED TO, THE IMPLIED WARRANTIES OF MERCHANTABILITY AND FITNESS FOR A PARTICULAR PURPOSE ARE DISCLAIMED. IN NO EVENT SHALL THE COPYRIGHT OWNER OR CONTRIBUTORS BE LIABLE FOR ANY DIRECT, INDIRECT, INCIDENTAL, SPECIAL, EXEMPLARY, OR CONSEQUENTIAL DAMAGES (INCLUDING, BUT NOT LIMITED TO, PROCUREMENT OF SUBSTITUTE GOODS OR SERVICES; LOSS OF USE, DATA, OR PROFITS; OR BUSINESS INTERRUPTION) HOWEVER CAUSED AND ON ANY THEORY OF LIABILITY, WHETHER IN CONTRACT, STRICT LIABILITY, OR TORT (INCLUDING NEGLIGENCE OR OTHERWISE) ARISING IN ANY WAY OUT OF THE USE OF THIS SOFTWARE, EVEN IF ADVISED OF THE POSSIBILITY OF SUCH DAMAGE.

#### **Declarations of Conformity**

This device complies with Part 15 of the FCC Rules. Operation is subject to the following two conditions:

1. This device may not cause harmful interference
2. This device must accept any interference received, including interference that may cause undesired operation.

This equipment has been tested and found to comply with the limits of a Class B digital device, pursuant to Part 15 of the FCC Rules. These limits are designed to provide reasonable protection against harmful interference in a residential installation. This equipment generates, uses and can radiate radio frequency energy and, if not installed and used in accordance with the instructions, may cause harmful interference to radio communications. If this equipment does cause harmful interference to radio or television reception, which can be determined by turning the equipment off and on, the user is encouraged to try to correct the interference by one or more of the following measures:

1. Reorient or relocate the receiving antenna.
2. Increase the separation between the equipment and receiver.
3. Connect the equipment into an outlet on a different circuit from that to which the receiver is connected.
4. Consult the dealer or an experienced radio/TV technician for help.

NOTE: The use of non-shielded cable with this equipment is prohibited.

CAUTION: Changes or modifications not expressly approved by the manufacturer responsible for compliance could void the user's authority to operate the equipment.

Apogee Electronics Corp.  
1715 Berkeley Street  
Santa Monica, CA 90404, USA

**Industry Canada Notice**

This Class B digital apparatus meets all requirements of the Canadian Interference-Causing Equipment Regulations. Cet appareil numérique de la classe B respecte toutes les exigences du Règlement sur le matériel brouilleur du Canada.

**Declaration of Conformity – CE**

Apogee Electronics Corporation hereby declares that the product, the Duet, to which this declaration relates, is in material conformity with the following standards or other normative documents:

- EN50081-1/EN55022; 1995
- EN50082-1/IEC 801-2, 3, 4; 1992

following the provisions of:

- 73/23/EEC – Low Voltage Directive
- 89/336/EEC – EMC Directive

**Declaration of Conformity – Japan**

Apogee Electronics Corporation hereby declares that Duet, to which this declaration relates, is in material conformity with the VCCI Class A standard.

**Declaration of Conformity – Australia**

Apogee Electronics Corporation hereby declares that the Duet is in material conformity with AN/NZS standard requirements.



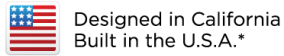

\*Apogee products are built in the U.S.A. using domestic and foreign parts and components.

Apogee Electronics Corp. Santa Monica, CA  
[www.apogeedigital.com](http://www.apogeedigital.com)